

LANGUAGES



INSTRUCTION MANUAL



ASUGA¹ ROLLER XLR

Check that you have the latest version of this manual before each use.

Contrôlez avant chaque utilisation de ce manuel si vous en avez la dernière version.

Überprüfen Sie vor jedem Gebrauch dieses Handbuchs, ob Sie die neueste Version haben.

Controleer voor elk gebruik van deze handleiding of u over de laatste versie beschikt.

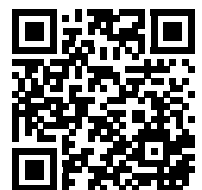

C-00488 Manual (Version4)

www.corally.com

www.corally.com

INTRODUCTION • QUICK START GUIDE



Thank you for purchasing a Team Corally car. This manual describes the instructions for using the model and the electronic components. You will also find some tips on how to maintain your RC model so that you can enjoy it for years to come. You have purchased one of the most efficient models available on the market that has been designed by a team of professionals. You will also benefit from the best after-sales support. All Team Corally models guarantee a high quality of manufacture and performance that guarantees you a high satisfaction of use and services provided by the Team Corally. Always take the time to read the instructions carefully in order to follow all the procedures to use your RC model safely for you and for other people and property in the area. This will allow you to take full advantage of all the performance of your RC model.

Please also check the website www.corally.com/Downloads/ to check if you have the latest version of this instruction manual. (Version: see bottom cover of this manual)

If you have any questions about the model and its components, you can send a message to info@corally.com

We also recommend that you get help from an experienced model maker or your dealer.

You will find all the references of the spare parts on the website www.corally.com

TERM OF USE

The user is responsible for the use of your model. The user assumes all risks associated with the use of the model. This model is not intended for use by children under 14 years of age without the supervision of a responsible adult who is familiar with the dangers of using a RC model. Team Corally / JSP Group Intl bvba, its manufacturers, distributors and resellers cannot control the use and load of the model and therefore cannot be held responsible for any damage to property and damage caused to persons resulting from the use of this product. You must accept these conditions and consider yourself fully responsible for the use of this product. If not, do not use this product.

Due to the continuous development of our products, the exact specifications of the kit may vary. If you have a problem with your new kit, please contact the store where you purchased it, indicating the part number(s).

Team Corally / JSP Group Intl bvba reserves the right to change any specification without notice. All rights reserved.

READ FIRST • QUICK START GUIDE

This owner's manual is designed for use with your vehicle and contains the instructions you will need to operate and maintain your vehicle.

- We know you want to start driving immediately after unpacking, but it is very important that you take the time to read this manual carefully, even if you are an experienced R/C driver.
- Read carefully and follow all instructions in this manual. Failure to comply with the instructions will be considered as abuse and/or negligence which may result in the cancellation of the warranty.
- Your vehicle is designed to operate on uneven terrain. However, dust, sand, water and carpet fibres can get into your car's workspaces and can damage your vehicle if they are not removed quickly. We do not guarantee any warranty on your vehicle against damage caused by external elements such as sand, dirt or water. Users are responsible for the maintenance and safe operation of this vehicle.
- This product is not a toy. It is not suitable for users under 14 years of age, unless they are supervised by adults.
- Never attempt to disassemble electronic components. These have been carefully calibrated at the factory.
- Only improve your car with parts made for your car. If you upgrade performance, replace the entire system (such as the motor, inverter, battery, etc.) so that all components are properly adapted. Any malfunction resulting from a custom modification will void your warranty.
- Before driving your vehicle, please read this manual in its entirety and examine your vehicle and radio control system for any defects.
- For better performance, some adjustments may be necessary.
- This vehicle requires a battery (included in the car or in the packaging). Make sure the vehicle's battery is sufficiently charged before driving, otherwise you may lose control of the vehicle.
- The radio transmitter requires 4 AA batteries (not included)
- Always remove or disconnect the battery from the vehicle to the inverter when not in use.
- Please drive your car in a spacious place. Never drive your car on the street or in traffic. Public places are subject to specific legislation by country, city, municipality, please comply with the legislation for the use of RC models in your region.
- This product is fully assembled in the factory. We accept no liability for damage and/or accidents resulting from custom modifications and/or malfunctions.

SAFETY PRECAUTIONS • QUICK START GUIDE

For your safety, always use wear gloves and goggles when assembling and maintaining your model.

Always take all necessary precautions when handling products (silicone oil, grease, thread lock, cyanolyte glue, fuel) for the operation of the model. (Refer to the manufacturer's instructions)

For your safety, to keep the warranty and obtain the best performance, always use original CORALLY genuine parts.

Contains: LEAD (CAS 7439-92-1) ANTIMONY (CAS 7440-36-0)

WARNING: This product contains a chemical known to the state of California to cause cancer and birth defects or other reproductive harm.

CAUTION: CANCER HAZARD

Contains lead, a listed carcinogen. Lead is harmful if ingested. Wash thoroughly after using.

DO NOT use product while eating, drinking or smoking.

USE PRECAUTIONS • QUICK START GUIDE



Failure to operate your model in a safe and responsible manner may result in injury to yourself, others or damage to property around you.

- Do not use your model on public roads or in areas where you may encounter pedestrians or riders.
- Do not operate in a congested area or in crowds.
- Do not operate in areas where loud noises can disturb others, such as hospitals and residential areas.
- Do not operate your model with obstructed line of sight, at night or near water.
- Your model is radio controlled, it is subject to possible radio interference. Radio interference can cause loss of control of your model. Be careful.
- Take care not to injure yourself while using tools to adjust or upgrade your model.
- Since the model contains small parts, keep out of reach of children while assembling and/or disassembling your model.
- If your model becomes stuck against an object, release the throttle and retrieve it by hand
- Do not continue to apply the throttle when your model is stuck. This may damage the motor and/or ESC/Receiver unit.
- Turn OFF your model and don't use it if it runs erratically. Please do not use your model again until the problem has been solved.
- Keep the wheels of the model off the ground when checking the operation of the radio equipment.
- When learning to operate your model, go to an area that has no obstacles that can damage your model.
- Before and after each use, check all the screws on the model.
- To maintain the best performance, check that all moving parts move freely.

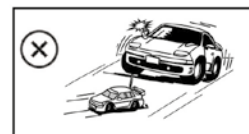

Take all necessary precautions before, during and after using your model. You are responsible for the safe assembly, maintenance and use of your model.

In case of any questions, contact your local reseller or contact Team Corally support for assistance.

LIPO BATTERY SAFETY PRECAUTIONS • QUICK START GUIDE

- Follow and respect the manufacturer's instructions for use
- It is important to check that your ESC is set to LIPO if you are using a LIPO battery. Failure to comply with this instruction will result in increased battery discharge and may cause fire and damage to persons and property.
- When charging or storing LiPo batteries always use LiPo Safety Bag (Flame retardant).
- Always respect the maximum rate and voltage specified by the battery manufacturer.
- Charge the LIPO battery outdoors or in a ventilated area away from flammable objects and surfaces.
- NEVER leave your LiPo battery unattended while charging.
- If the battery swells during charging, stop charging immediately and disconnect the battery from the charger. Leave the battery outside for a few hours and observe. Then recycle the battery according to the instructions of your country/region. Never dispose of a LIPO battery with domestic waste.
- Before recycling your defective battery, it must be neutralized. Take a plastic container, fill it with water and add a lot of salt until the water becomes opaque. Place the LIPO battery in the water and leave for 24 hours. Check with a voltmeter that the voltage is 0.0V. Then recycle the battery according to local regulations.
- Never charge a damaged or inflated battery.
- Never discharge the battery cells below 3.2V.
- Always use the appropriate balancer/charger when charging your LiPo battery pack.
- When the battery is empty, check the temperature of the battery before charging it. If the battery is very hot, wait until it cools before charging it.
- Never charge a very hot battery as this may cause an explosion or fire.
- When the battery is empty, recharge it immediately. Do not store an empty battery, the battery will continue to discharge, it will fall below the minimum voltage and become unusable.

WARRANTY • QUICK START GUIDE



If material defects or manufacturing faults should arise in a product distributed or manufactured by Team Corally / JSP Group Intl bvba, and purchased by a consumer, we Team Corally / JSP Group Intl bvba acknowledge the obligation to correct those faults or defects within the limitations described below. This manufacturer's warranty is in addition to, and does not affect, the legal or contractual rights of the consumer which arise from the purchase of such products. Team Corally / JSP Group Intl bvba guarantees the consumer that its products are free from material, manufacturing, and construction faults, as determined by the general state of knowledge and technology valid at the time of manufacturing. The fault responsible for causing the damage must be proven to have been present in the product at this time. Claims for compensation arising from consequential damage or product liability will not be considered valid unless they fall under peremptory provisions of the law. If material defects or manufacturing faults should arise in a product distributed or manufactured by Team Corally / JSP Group Intl bvba in the European community (EC) and purchased by a consumer, then Team Corally / JSP Group Intl bvba undertakes to correct those defects within the limitations described below. This manufacturer's declaration does not affect the consumer's legal or contractual rights regarding defects arising from the purchase contract between the consumer and the dealer or reseller. Extend of the Warranty

If a claim is made under warranty, we take at our discretion to repair or replace the defective goods. We will not consider supplementary claims, especially for reimbursement of costs relating to the defect (e.g. installation / removal costs) and compensation for consequent damages unless they are allowed by statute. This does not affect claims on legal regulations, especially according to the product liability law.

Provisions of the Warranty

The purchaser is required to make the warranty claim in writing, and must enclose original proof of purchase (e.g. invoice, receipt, delivery note) and the appropriate warranty card. He must send the defective goods to our local representatives or directly to Team Corally / JSP Group Intl bvba, Geelseweg 80, 2250 Olen, Belgium at his own risk and cost.

The purchaser should state the material defect or manufacturing fault, or symptoms of the fault, as accurate as possible, so that we can check if our warranty obligation is applicable. The goods are transported from the consumer to us, and from us to the consumer, entirely at the risk and cost of the consumer.

Invalidation of the Warranty

The consumer cannot make a claim under warranty when the fault is affecting the use of the product arising from natural wear, competition use, or improper use (including installation) or external forces. The consumer's adherence to the building and operating instructions relevant to the model, including the installation, operation, use of, and maintenance of, model-related components cannot be supervised by Team Corally / JSP Group Intl bvba. Therefore Team Corally / JSP Group Intl bvba is in no way liable for loss, damage, or costs resulting from improper use, or behaviour in any way connected to the above described provisions. Unless otherwise required by law, Team Corally / JSP Group Intl bvba is in no way whatever liable to provide compensation for damages arising from the improper use of the model (including personal injury, death, damage to buildings, loss of turnover, loss of business, or interruption of business, or any other direct, or indirectly caused, consequential damage).

Duration of Validity

The claim period is 24 months from the date of purchase of the product by the consumer from a dealer in the European Community (EC) counted from the date of purchase. The claim period is 12 months from the date of purchase of the product by the consumer from a dealer outside the European Community (EC) counted from the date of purchase. If a defect arises after the end of the claim period, or if evidence or documents required according to this declaration in order to make the claim valid are not presented until after this period, then the consumer forfeits any rights or claims from this declaration. The guarantee period is not prolonged by the granting of any claims within the framework of this warranty, especially in the case of repair or replacement. The guarantee period also does not restart in such cases.

Warranty Expiration

If we do not acknowledge the validity of a claim based on this declaration within the claim period, all claims based on this declaration will expire after six months from the time of registering the claim; however this cannot occur prior to the end of the claim period.

For any support, contact us at support.corally.com

DOWNLOAD • QUICK START GUIDE

 Download the latest version of this manual and other languages.

Download updated PDF pages of : *Spare parts - Option Parts - Exploded Views - Screws Chart ...*

www.corally.com/Downloads/

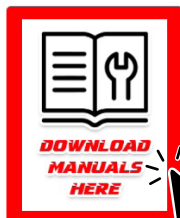

“DOWNLOAD”
Home page / right column

Click !



“DOWNLOAD”
Select a category



Click !

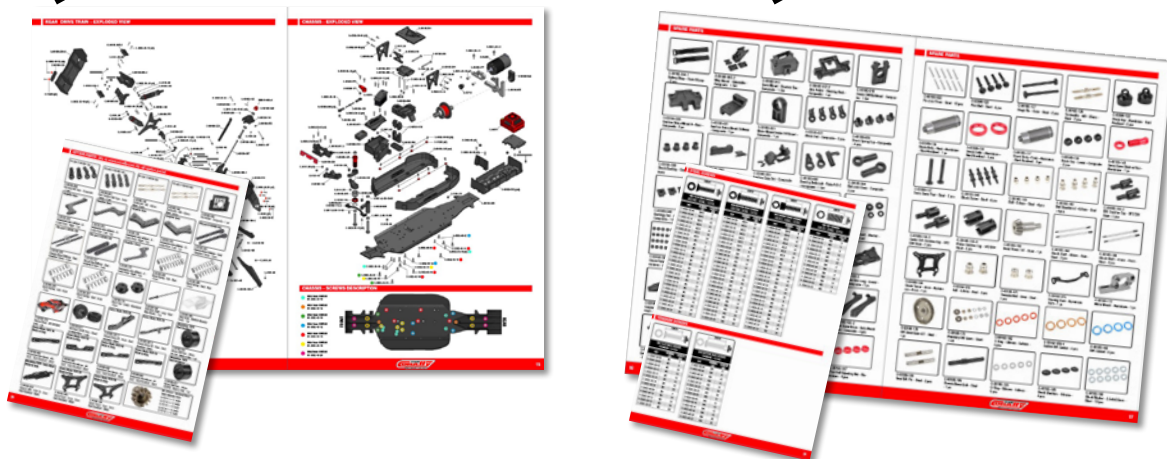

KIT CONTENT



RTR Model (Without electronic equipment)



User Guide

REQUIRED FOR OPERATION (Not included)



2-Channel Remote Control System



Recommended #C-52001

CS-5226 Servo
25.6Kg - 0.07 sec
Titanium Gears
Waterproof



Recommended #C-54011

TOROX 185 BLS Controller
2-6S - 150A
Sensorless
Waterproof



Recommended #C-54055

KURON 825 BLS Motor
4-POLE - 2050 KV
Sensorless

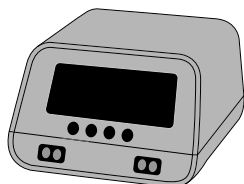

Charger

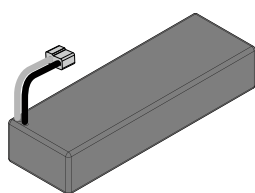

LiPo Battery 4-6S



Silicone Oil
(Shocks - Differentials)



Silicone Oil
(Shocks - Differentials)



Cross Wrench

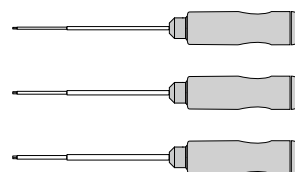

Hex Drivers 1.5 - 2.0 - 2.5 - 3.0

CAR COMPONENTS • QUICK START GUIDE

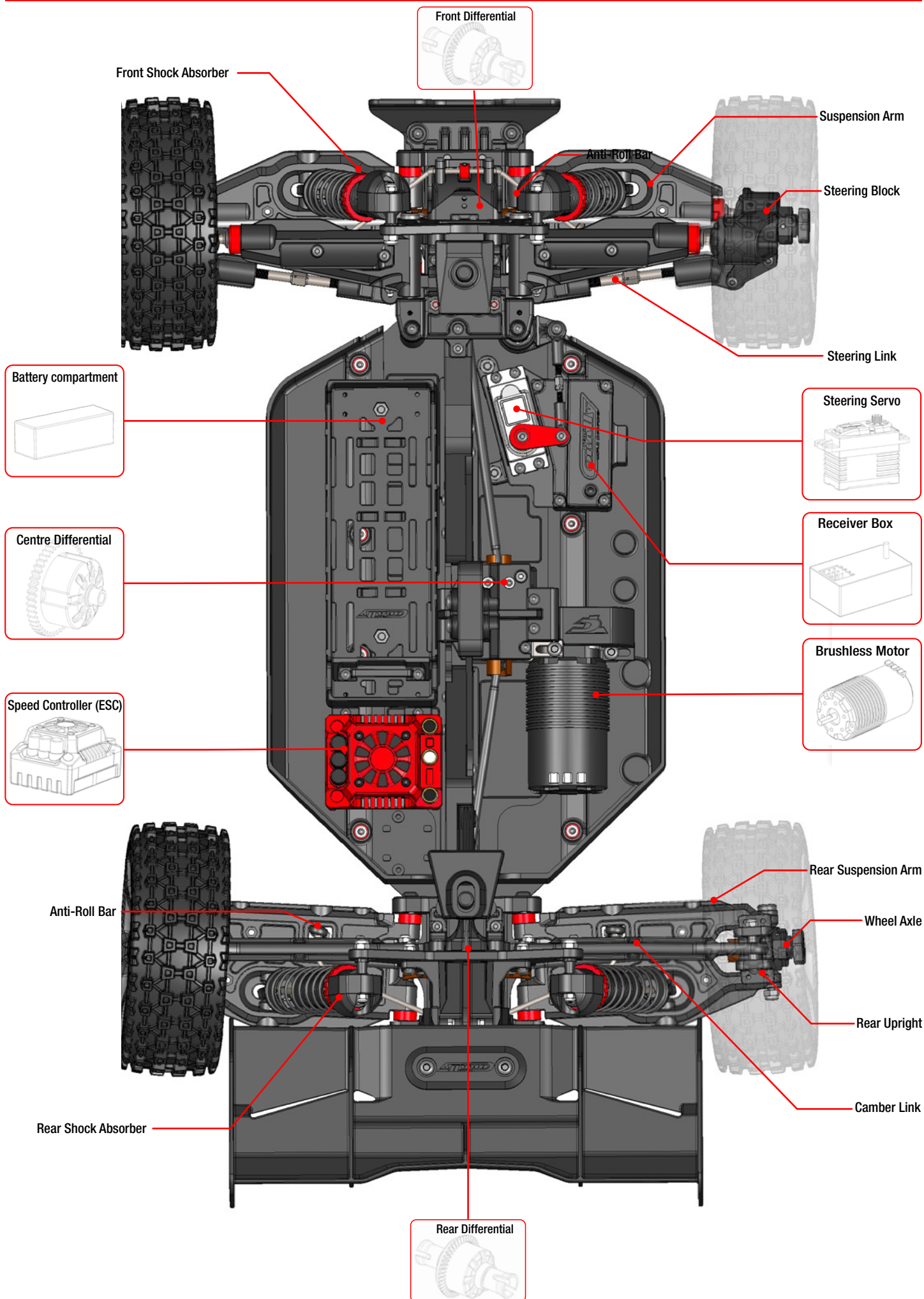

FOLLOW THE STEPS • QUICK START GUIDE



READ THE INSTRUCTIONS

Instruction

CHARGE THE BATTERY

INSTALL 4x AA BATTERY - 1.5V

MAKE SURE THAT ALL SCREWS AND NUTS ARE TIGHTENED PROPERLY.

INSTALL THE BATTERY

TURN ON THE TRANSMITTER (Always First)

CONNECT THE BATTERY TO THE ESC SWITCH ON THE ESC

CHECK THE FUNCTIONS

CHECK THE RADIO SYSTEM RANGE

Move away from the max. distance you will drive the vehicle.
Check that the vehicle responds properly to the controls.
If not, reduce the distance or change the driving location.

DRIVE SLOWLY TO BEGIN

WHEN FINISHING

-
-
-
-

CLEAN AND MAINTAIN YOUR VEHICLE



1 SERVO INSTALLATION



Recommended Servo :
Digital Servo - CS-5226 - High Voltage
#C-52001

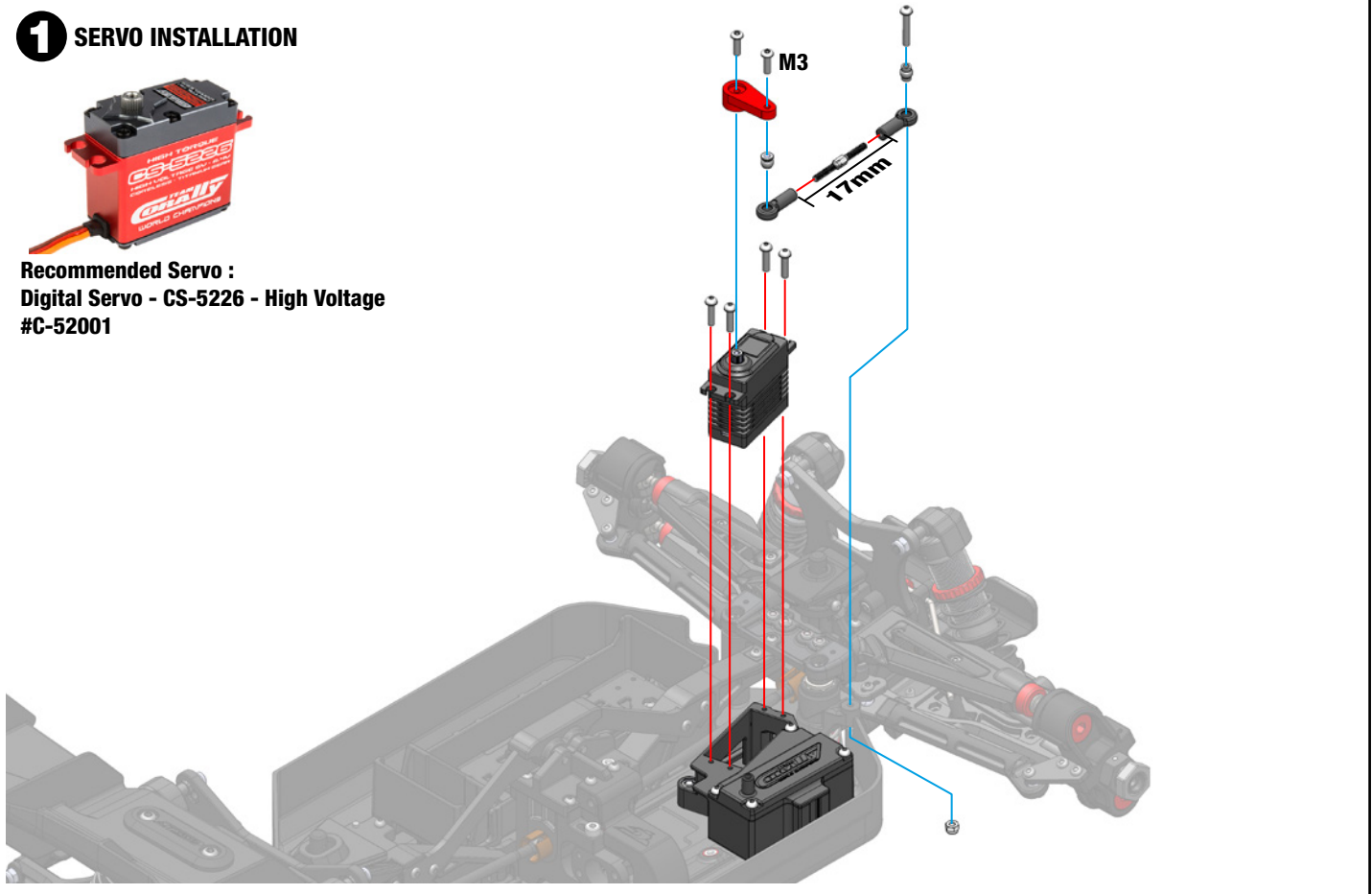

2 ESC INSTALLATION



Recommended ESC :
Speed Controller - TOROX 185 -
Brushless - 2-6S
#C-54011

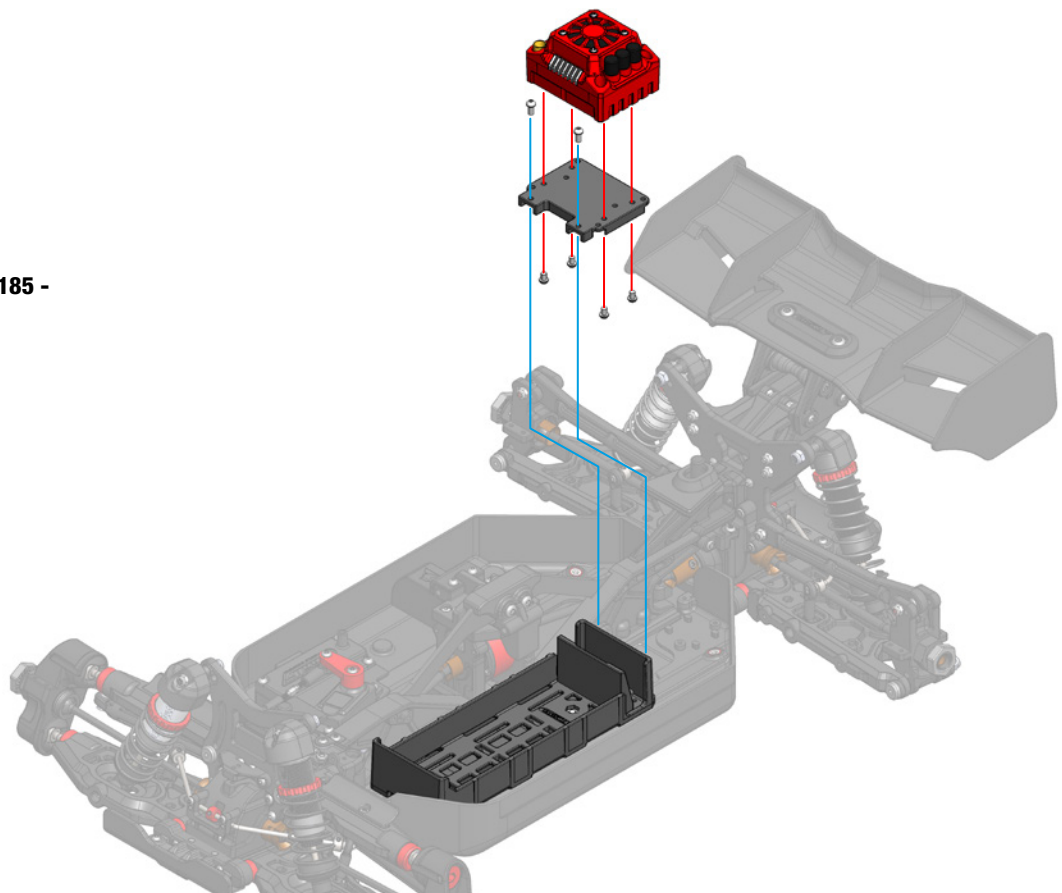



3 MOTOR INSTALLATION

IMPORTANT : See also the section : "GEAR MESH ADJUSTMENT"

Voyez aussi la section : "AJUSTEMENT DE L'ENTRE-DENTS"

Siehe auch den Abschnitt : "GETRIEBEVERSTELLUNG"

Zie ook de rubriek : "TANDWIELAFSTELLING"

Connect the motor to the controller as described in the controller manual.

Connectez le moteur au contrôleur comme décrit dans le manuel du contrôleur.

Schließen Sie den Motor an den Regler an, wie in der Bedienungsanleitung des Reglers beschrieben.

Sluit de motor aan op de regelaar zoals beschreven in de handleiding van de regelaar.

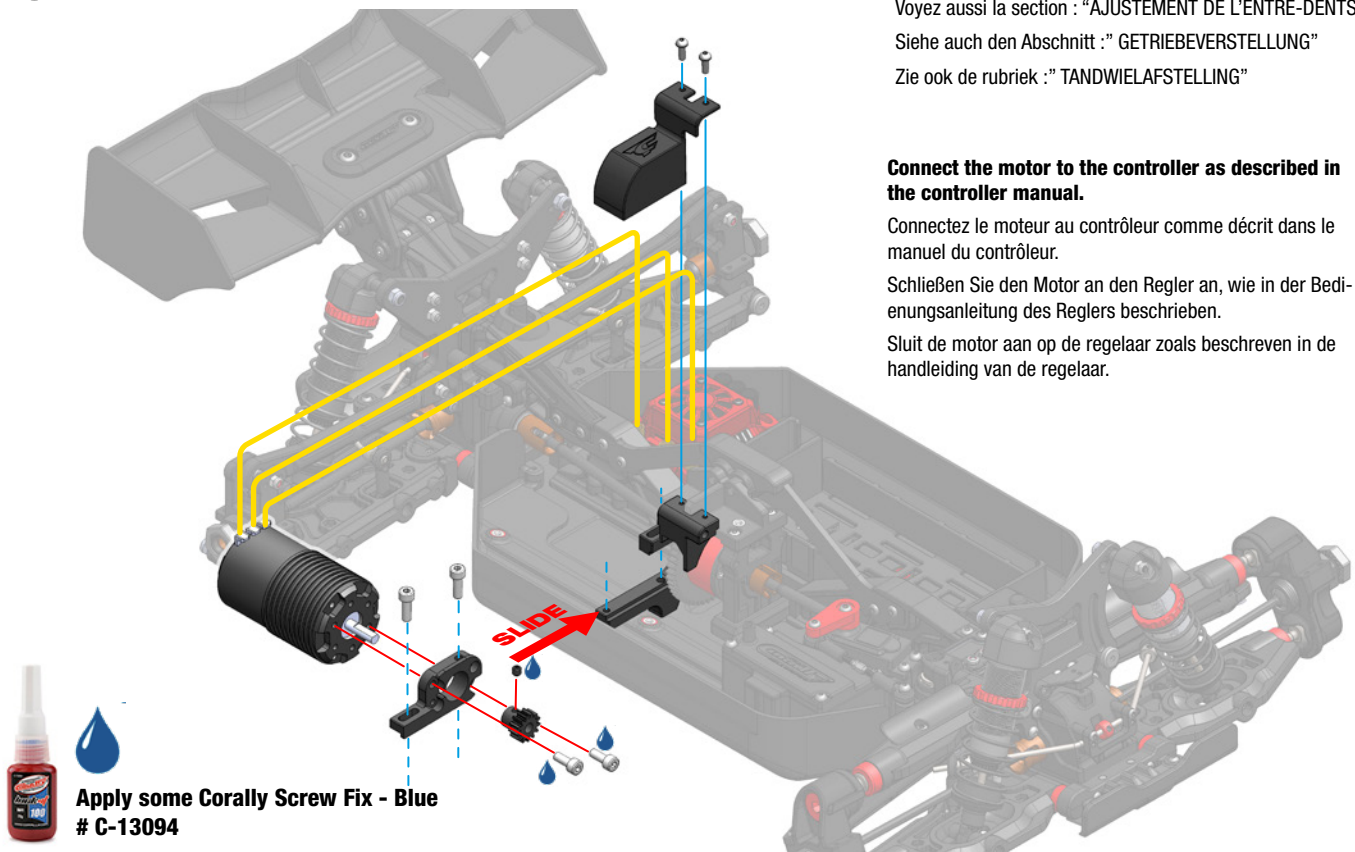

Apply some Corally Screw Fix - Blue
C-13094

4 RECEIVER INSTALLATION

**Connect the servo cable to channel 1 of the receiver.
Connect the ESC cable to channel 2 of the receiver.**

Connectez le câble du servo au canal 1 du récepteur.

Connectez le câble de l'ESC au canal 2 du récepteur.

Schließen Sie das Servokabel an Kanal 1 des Empfängers an.

Schließen Sie das ESC-Kabel an Kanal 2 des Empfängers an.

Sluit de servokabel aan op kanaal 1 van de ontvanger.

Sluit de ESC-kabel aan op kanaal 2 van de ontvanger.

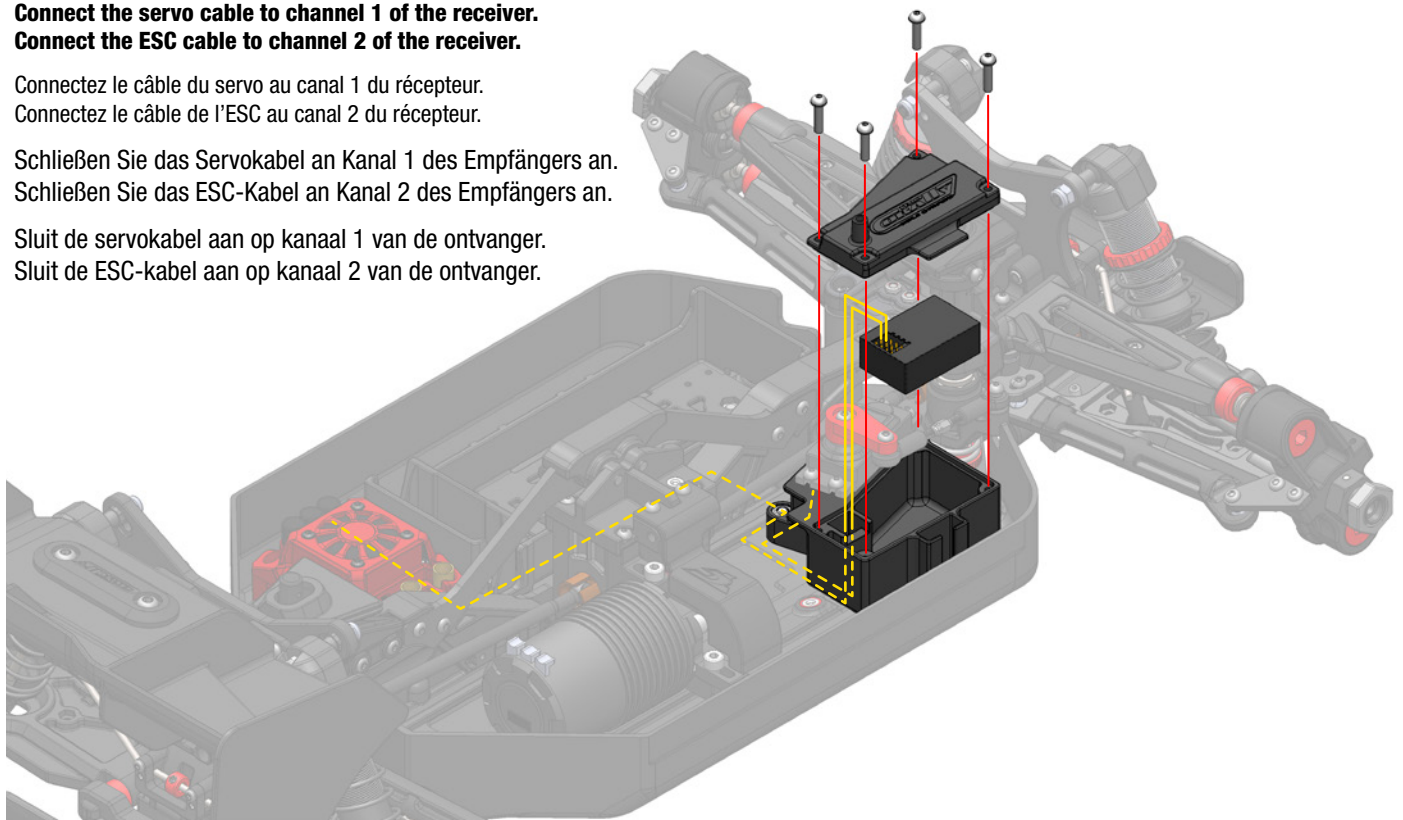

GEAR RATIO

MOTOR PINION MOD1.0 - PIGNON MOTEUR MOD1.0 - MOTORRITZEL MOD1.0 - MOTOR PINION MOD1.0



High-performance pinions gear, manufactured from special steel for toughness and durability with precise tolerances and assures unparalleled concentricity. Created on a special gear machine, all pinions feature ultra-precise tooth shaping and ultra-true running for vibration-free operation. Each pinion is marked with the tooth number for easy and quick identification. Fits all cars with MOD1 gears (1/8 Scale)



Pignons Haute Performance, fabriqué en acier spécial avec des tolérances précises pour garantir solidité, longévité et concentricité. Tous les pignons présentent une forme de dent ultra-précise pour un fonctionnement sans vibrations. Chaque pignon est marqué du nombre de dents pour une identification facile et rapide. Convient à toutes les voitures avec des transmissions MOD1 (Echelle 1/8)



Hochleistungs-Ritzel, hergestellt aus Spezialstahl mit präzisen Toleranzen, um Festigkeit, Haltbarkeit und Rundlauf zu gewährleisten. Alle Ritzel haben eine ultrapräzise Zahnform für einen vibrationsfreien Betrieb. Jedes Kettenrad ist zur schnellen und einfachen Identifizierung mit der Anzahl der Zähne gekennzeichnet. Passend für alle Fahrzeuge mit MOD1-Getriebe (Maßstab 1/8)



High-performance tandwiel, geproduceerd van speciaal staal met nauwkeurige toleranties om sterkte, duurzaamheid en concentriciteit te garanderen. Alle kettingswielen hebben een ultra-precieze tandvorm voor een trillingsvrije werking. Elk tandwiel is gemarkeerd met het aantal tanden voor een snelle en eenvoudige identificatie. Past op alle auto's met MOD1 versnellingen (1/8 Schaal)

SPEED GEAR CHART - TABLEAU DES VITESSES - DREHZAHLGANGDIAGRAMM - VERSNELLINGSTABEL

With Spur Gear 46T - Gear Ratio 3.31

	Km/h	Mph	Km/h	Mph	Km/h	Mph	Km/h	Mph	Km/h	Mph	Km/h	Mph	Km/h	Mph	Km/h	Mph
Gear	11T Pinion		12T Pinion		13T Pinion		14T Pinion		15T Pinion		16T Pinion		17T Pinion		18T Pinion	
46T	13,83		12,68		11,71		10,87		10,14		9,51		8,95		8,45	
4S	58	36	63	39	69	43	74	46	79	49	84	52	90	56	95	59
6S	87	54	95	59	103	64	111	69	119	74	127	79	135	84	143	89

With Spur Gear 52T - Gear Ratio 3.31

	Km/h	Mph	Km/h	Mph	Km/h	Mph	Km/h	Mph	Km/h	Mph	Km/h	Mph
Gear	11T Pinion		12T Pinion		13T Pinion		14T Pinion		15T Pinion		16T Pinion	
52T	15,64		14,33		13,23		12,29		11,47		10,75	
4S	51	32	56	35	61	38	65	40	70	43	75	47
6S	77	48	84	52	91	57	98	61	105	65	112	70

■ OK
 ■ Factory fitted
 ■ Usable but not recommended
 ■ Not recommended, at your own risk



Note: The speed indicated in the table is a theoretical speed for information purposes. The real speed varies according to the type of terrain, electronic equipment, atmospheric conditions, type of tyre and its diameter and other driving parameters.

Note: La vitesse indiquée dans le tableau est une vitesse théorique à titre indicatif. La vitesse réelle varie en fonction du type de terrain, de l'équipement électronique, des conditions atmosphériques, du type de pneu et son diamètre et d'autres paramètres de conduite.

Bemerkung: Die in der Tabelle angegebene Geschwindigkeit ist eine theoretische Geschwindigkeit, die nur als Referenz dient. Die tatsächliche Geschwindigkeit hängt von der Art des Geländes, der elektronischen Ausrüstung, den Wetterbedingungen, des Reifentyps und seines Durchmessers und anderen Fahrparametern ab.

Nota: De in de tabel aangegeven snelheid is een theoretische snelheid, uitsluitend ter referentie. De werkelijke snelheid varieert afhankelijk van het soort terrein, de elektronische apparatuur, de weersomstandigheden, het type band en zijn diameter en andere rijparameters.

OPTION M1.0 Pinion - Hardened Steel - for Shaft Dia. 5mm

- C-72713** - Pinion 13 Teeth
- C-72714** - Pinion 14 Teeth
- C-72715** - Pinion 15 Teeth
- C-72716** - Pinion 16 Teeth
- C-72717** - Pinion 17 Teeth





If the gear mesh is not correct, you wear out the spur gear prematurely, the transmission will make noise, give unnecessary load on the motor (higher consumption, heating of the transmission).



Si l'espace entre le pignon et la couronne n'est pas correct, la couronne dentée s'use prématurément, la transmission fait du bruit et le moteur est inutilement sollicité (consommation plus élevée, échauffement de la transmission).



Wenn der Abstand zwischen Ritzel und Tellerrad nicht stimmt, verschleißt das Zahnrad vorzeitig, das Getriebe macht Geräusche und der Motor wird unnötig belastet (höherer Verbrauch, Erwärmung des Getriebes).



Als de afstand tussen het tandwiel en de recht tandwiel niet correct is, slijt de recht tandwiel voortijdig, maakt de transmissie lawaai en wordt de motor onnodig belast (hoger verbruik, verhitting van de transmissie).

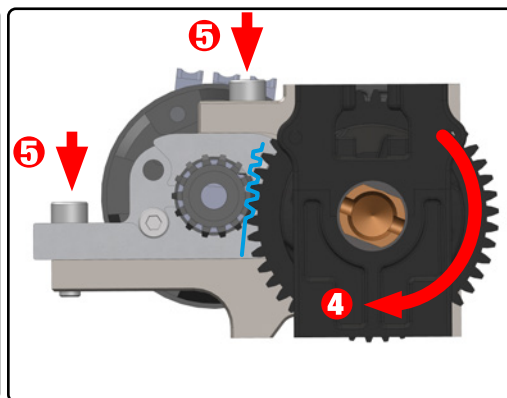
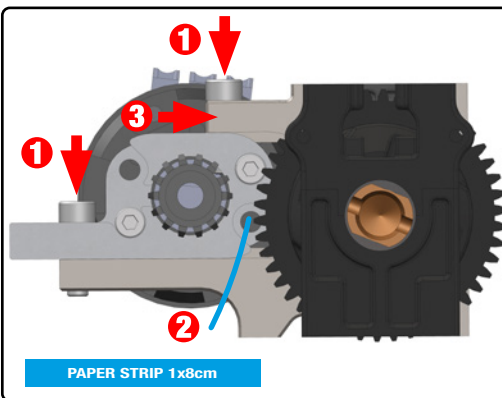
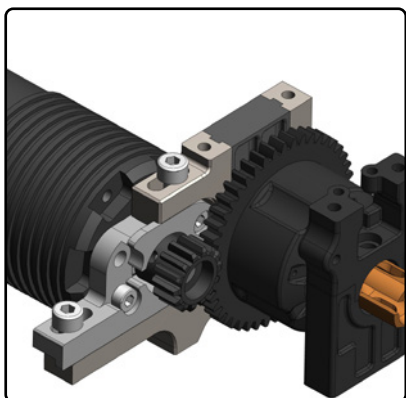

1. Loosen the screws.

*Desserrez les vis.
Lösen Sie die Schrauben.
Draai de schroeven los.*

2. Insert the paper strip.

*Insérez la bande de papier.
Legen Sie den Papierstreifen ein.
Plaats de papierstrook.*

3. Push the motor against the spur gear.

*Poussez le moteur contre la couronne dentée.
Schieben Sie den Motor gegen das Zahnrad.
Duw de motor tegen het recht tandwiel.*

4. Turn the spur gear to run the paper through the teeth.

**Stop when the paper is in the middle.
Make sure that the motor pinion is against the spur gear.**

*Tournez la couronne dentée pour faire passer le papier entre les dents.
Arrêtez lorsque le papier est au milieu.
Assurez-vous que le pignon du moteur est contre la couronne dentée.*

Drehen Sie das Hauptzahnrad, um das Papier durch die Zähne zu führen.
Halten Sie an, wenn sich das Papier in der Mitte befindet.
Achten Sie darauf, dass das Motorritzel am Hauptzahnrad anliegt.

*Draai aan het rechte tandwiel om het papier door de tanden te laten lopen.
Stop wanneer het papier in het midden is.
Zorg ervoor dat het motortandwiel tegen het rechte tandwiel staat.*

5. Maintain and tighten the fixing screws.

*Maintenez et serrez les vis de fixation.
Halten Sie die Befestigungsschrauben fest und ziehen Sie sie an.
De bevestigingsschroeven aanhouden en vastdraaien.*



It may be necessary to replace the silicone oil in the shock absorbers every 20 runs (depends on how you drive and the type of terrain you drive on).

Il peut être nécessaire de remplacer l'huile silicone des amortisseurs toutes les 20 courses (cela dépend de votre conduite et du type de terrain sur lequel vous roulez).



Es kann notwendig sein, das Silikonöl in den Stoßdämpfern alle 20 Fahrten zu wechseln (abhängig von Ihrer Fahrweise und dem Gelände, auf dem Sie fahren).

Het kan nodig zijn de siliconenolie in de schokdempers om de 20 ritten te vervangen (afhankelijk van uw rijstijl en het soort terrein waarop u rijdt).

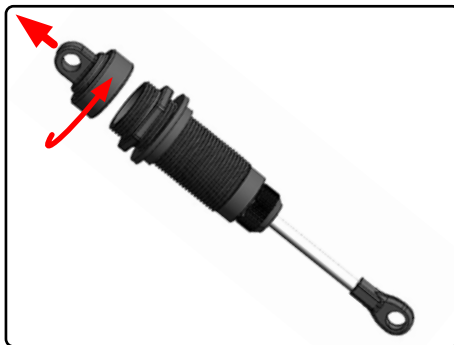
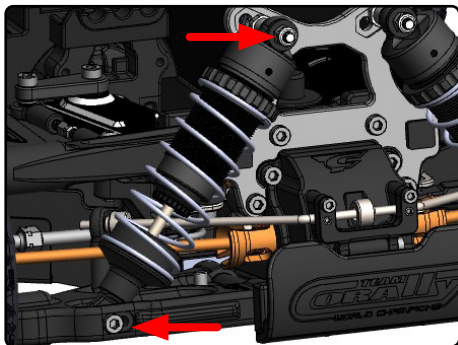

ATTENTION : ALWAYS USE SILICONE OIL, NEVER USE ANY OTHER TYPES OF OIL.

FILL	MOVE UP	WAIT	TIGHTEN 50%	MOVE UP	TIGHTEN FULLY
<p>2 FILL</p> <p>1 ↓</p>	<p>MOVE UP</p> <p>3-4x</p>	<p>WAIT</p> <p>5min</p>	<p>TIGHTEN 50%</p>	<p>MOVE UP</p> <p>SLOWLY</p>	<p>TIGHTEN FULLY</p>
<ul style="list-style-type: none"> • Fill the shock with silicone oil. • Remplissez l'amortisseur avec de l'huile de silicone. • Füllen Sie den Dämpfer mit Silikonöl. • Vul de schokdemper met siliconenolie. 	<ul style="list-style-type: none"> • Move the piston up&down (3-4x) to release the air bubbles in the silicone oil. • Déplacez le piston de haut en bas (3-4x) pour libérer les bulles d'air. • Bewegen Sie den Kolben nach oben&unten (3-4x), um die Luftblasen abzulassen. • Beweeg de zuiger op en neer (3-4x) om de luchtbelleten te laten ontsnappen. 	<ul style="list-style-type: none"> • Pull the Shock shaft down and wait until the bubbles rise to the surface. • Tirez la tige d'amortisseur vers le bas et attendez que les bulles remontent à la surface. • Ziehen Sie die Schockwelle nach unten und warten Sie, bis die Blasen an die Oberfläche steigen. • Trek de Schokas naar beneden en wacht tot de luchtbelleten naar de oppervlakte stijgen. 	<ul style="list-style-type: none"> • Screw in the shock absorber cap at 50%. • Vissez le bouchon d'amortisseur à 50% • Schrauben Sie die Stoßdämpferkappe zu 50 % ein. • Schroef de dop van de schokdemper op 50%. 	<ul style="list-style-type: none"> • Gently move the piston in upper position, the oil excess will flow out. • Déplacez doucement le piston en position haute, l'excédent d'huile s'écoulera. • Bewegen Sie den Kolben vorsichtig in die obere Position, das überschüssige Öl fließt dann heraus. • Beweeg de piston langzaam in de bovenste positie, de overtollige olie zal eruit stromen. 	<ul style="list-style-type: none"> • Now tighten the cap fully but not too much otherwise the membrane will be deformed. • Maintenant, serrez le bouchon à fond, mais pas trop, sinon la membrane sera déformée. • Ziehen Sie nun die Kappe vollständig, aber nicht zu fest an, da sonst die Membran verformt wird. • Draai nu de dop helemaal vast, maar niet te vast, anders wordt het membraan vervormd.

www.corally.com/Chemicals/Silicone-Oils/

	FRONT		REAR		SHOCK PISTON
	SILICONE OIL	SPRING TENSION	SILICONE OIL	SPRING TENSION	
TRACK USE	1000CPS	4mm	800CPS	0mm	8 Holes Ø1.2mm
OFF-ROAD	800CPS	4mm	700CPS	0mm	8 Holes Ø1.2mm
BASHING	1000CPS	4mm	800CPS	0mm	8 Holes Ø1.2mm
FACTORY	500CPS		500CPS		8 Holes Ø1.2mm

SHOCK ABSORBER - AMORTISSEUR - STOSSDÄMPFER - SCHOKDEMPER



- Do not overtighten the Shock Cap to prevent deformation of the silicone Shock Bladder.
- Ne serrez pas trop le capuchon de l'amortisseur pour éviter la déformation de la membrane en silicone.
- Ziehen Sie die Dämpferabdeckung nicht zu fest an, um eine Verformung der Silikonmembran zu vermeiden.
- Draai de schokkap niet te strak aan om vervorming van het siliconenmembraan te voorkomen.

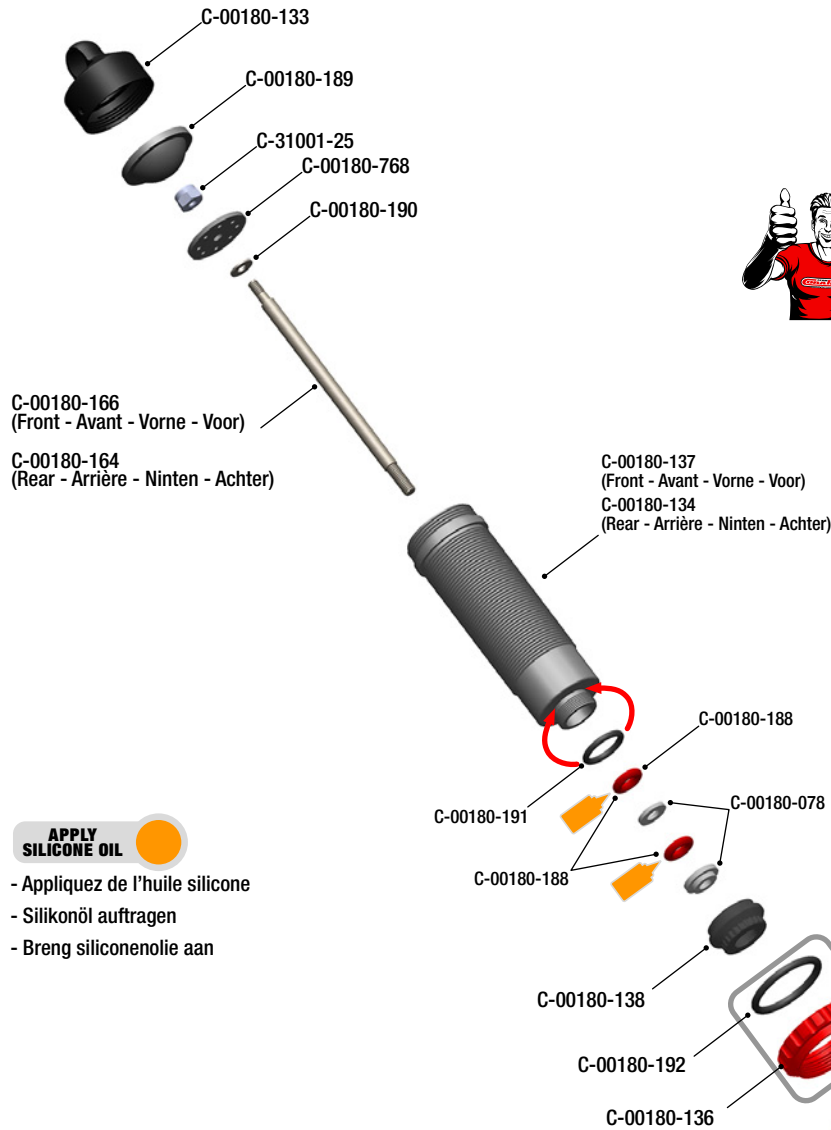

APPLY SILICONE OIL

- Appliquez de l'huile silicone
- Silikonöl auftragen
- Breng siliconenolie aan

OPTION

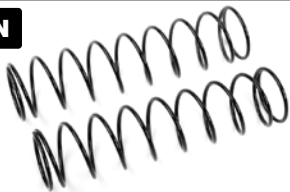

REF		TYPE	POSITION	THICKNESS	LENGTH
C-00180-289	Shock Spring	SOFT	FRONT	1.4mm	L: 84-86mm
C-00180-290	Shock Spring	MEDIUM	FRONT	1.6mm	L: 84-86mm
C-00180-291	Shock Spring	HARD	FRONT	1.8mm	L: 84-86mm
C-00180-286	Shock Spring	SOFT	REAR	1.4mm	L: 95-97mm
C-00180-287	Shock Spring	MEDIUM	REAR	1.6mm	L: 95-97mm
C-00180-288	Shock Spring	HARD	REAR	1.8mm	L: 95-97mm



C-00180-768 Shock Piston (8pcs)
 Shock Piston - **6 Holes 1.4**
 Shock Piston - **8 Holes 1.2** (Factory installed)



- Place all small parts on a screwdriver (Ø3mm) and push them into the shock body. All parts will be properly aligned.
- Placez toutes les petites pièces sur un tournevis (Ø3mm) et poussez-les dans le corps de l'amortisseur. Toutes les pièces seront correctement alignées.
- Setzen Sie alle Kleinteile auf einen Schraubendreher (Ø3mm) und drücken Sie sie in den Dämpferkörper. Alle Teile werden richtig ausgerichtet.
- Plaats alle kleine onderdelen op een schroevendraaier (Ø3mm) en duw ze in de behuizing van de schokdemper. Alle onderdelen zullen goed uitgelijnd zijn.

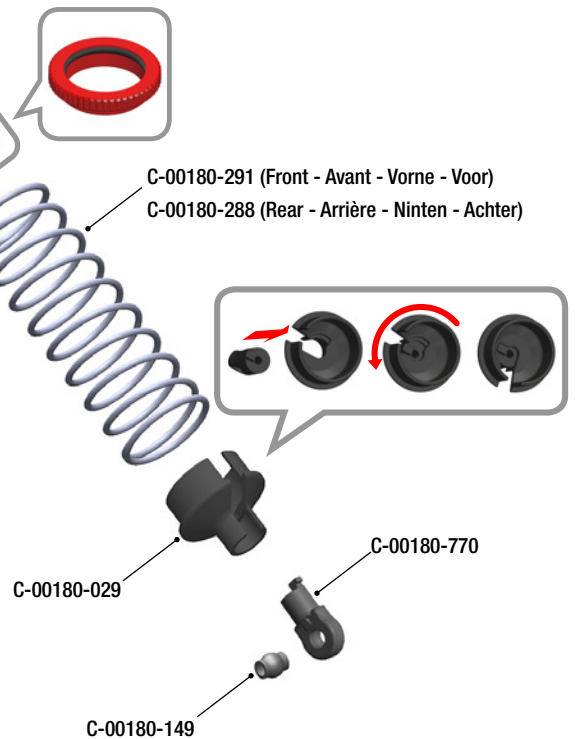

It may be necessary to replace the silicone oil every 50 runs (depends on how you drive and the type of terrain you drive on).

Il peut être nécessaire de remplacer l'huile silicone toutes les 50 courses (cela dépend de votre conduite et du type de terrain sur lequel vous roulez).

Es kann notwendig sein, das Silikonöl alle 50 Fahrten zu wechseln (abhängig von Ihrer Fahrweise und dem Gelände, auf dem Sie fahren).

Het kan nodig zijn de siliconenolie om de 50 ritten te vervangen (afhankelijk van uw rijstijl en het soort terrein waarop u rijdt).

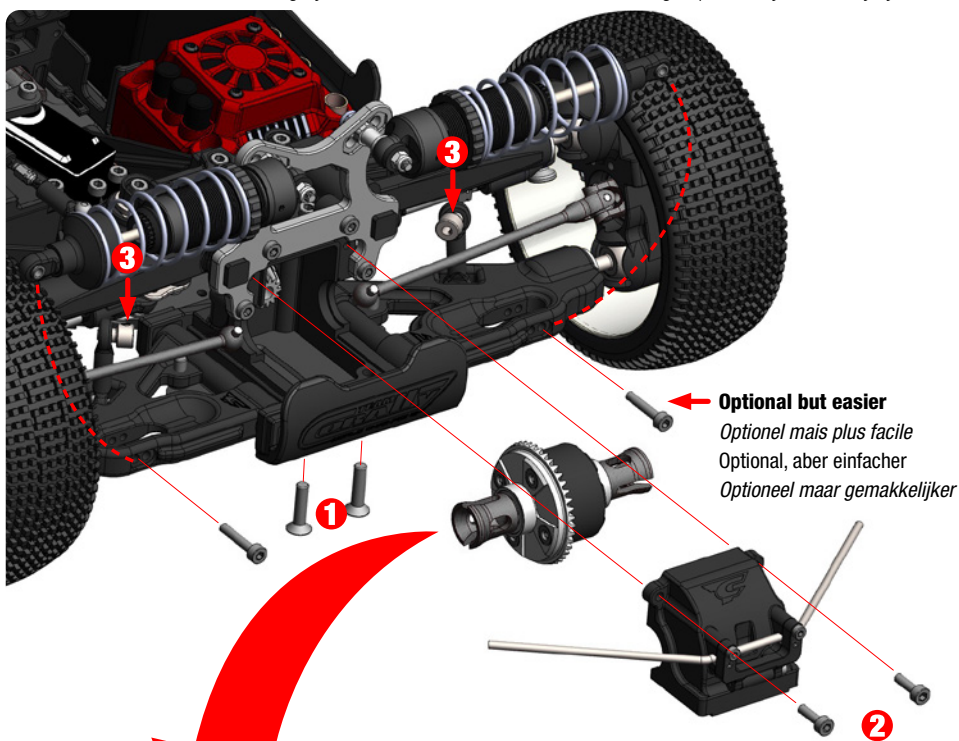

- **1. Remove 2 screws under the chassis.**
Retirez 2 vis sous le châssis.
Entfernen Sie 2 Schrauben unter dem Chassis.
Verwijder 2 schroeven onder het chassis.
- **2. Remove the screws from the differential cover.**
Retirez les vis du couvercle du différentiel.
Entfernen Sie die Schrauben des Differentialdeckels.
Verwijder de schroeven van het deksel van het differentieel.
- **3. Unscrew the ANTI-ROLL BAR Screws.**
Dévissez les vis de la barre anti-roulis.
Lösen Sie die ANTI-ROLL BAR-Schrauben.
Schroef de ANTI-ROLL BAR-schroeven los.
- **4. Unscrew the differential. (4x F/H M3x10)**
Ouvrir le différentiel.
Öffnen Sie das Differential.
Open het differentieel.
- **5 Drain the silicone oil from the differential.**
Vidangez l'huile de silicone du différentiel.
Lassen Sie das Silikonöl aus dem Differential ab.
Laat de siliconenolie uit het differentieel lopen.
- **6 Fill with new silicone oil (75% capacity max.)**
Remplir avec de l'huile silicone neuve (75% max.)
Füllen Sie neues Silikonöl ein (max. 75% Füllmenge).
Vullen met nieuwe siliconenolie (75% capaciteit max.)

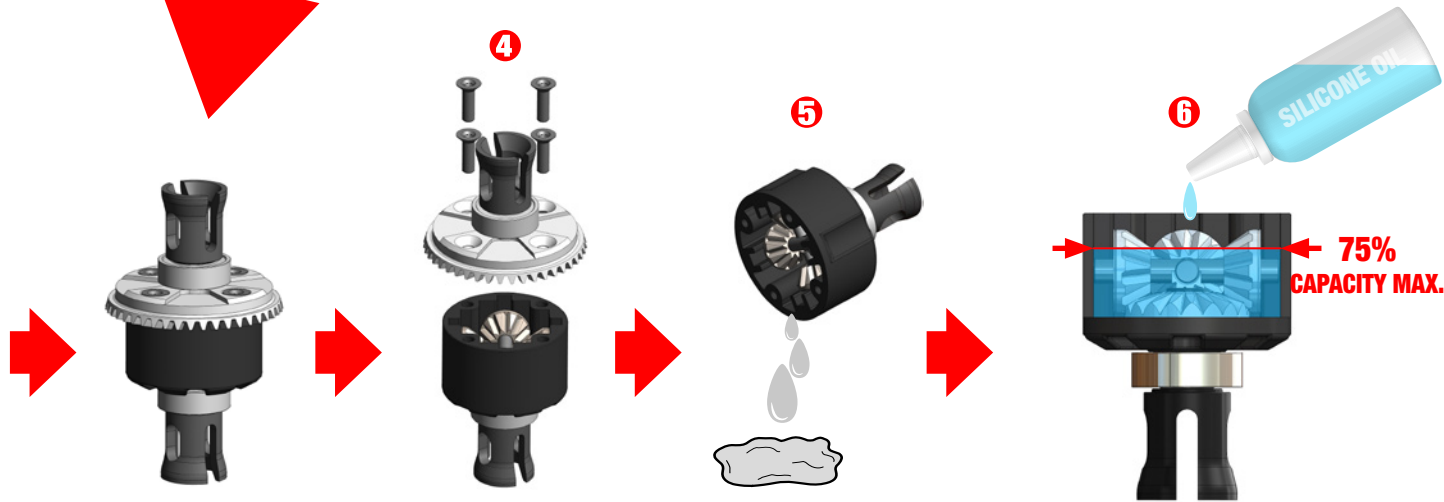

Perform the same maintenance operation for the Centre and Rear differentials.

Effectuez la même opération d'entretien pour les différentiels central et arrière.

Führen Sie die gleichen Wartungsarbeiten für das mittlere und hintere Differential durch.

Doe dezelfde onderhoudswerkzaamheden voor het midden- en achterdifferentieel.



	FRONT DIFF	CENTRE DIFF	REAR DIFF
TRACK USE	100.000CPS	100.000CPS	50.000CPS
OFF-ROAD	10.000CPS	10.000CPS	7.500CPS
FACTORY	30.000CPS	100.000CPS	20.000CPS

www.corally.com/Chemicals/Silicone-Oils/



It may be necessary to replace the silicone oil every 50 runs (depends on how you drive and the type of terrain you drive on).



Il peut être nécessaire de remplacer l'huile silicone toutes les 50 courses (cela dépend de votre conduite et du type de terrain sur lequel vous roulez).



Es kann notwendig sein, das Silikonöl alle 50 Fahrten zu wechseln (abhängig von Ihrer Fahrweise und dem Gelände, auf dem Sie fahren).



Het kan nodig zijn de siliconenolie om de 50 ritten te vervangen (afhankelijk van uw rijstijl en het soort terrein waarop u rijdt).

- Follow the disassembly sequence to remove the centre differential.

- Suivez l'ordre de démontage pour extraire le différentiel central.

- Folgen Sie der Reihenfolge der Demontage, um das Mitteldifferential herauszuziehen.

- Volg de demontagevolgorde om het middendifferentieel te verwijderen.

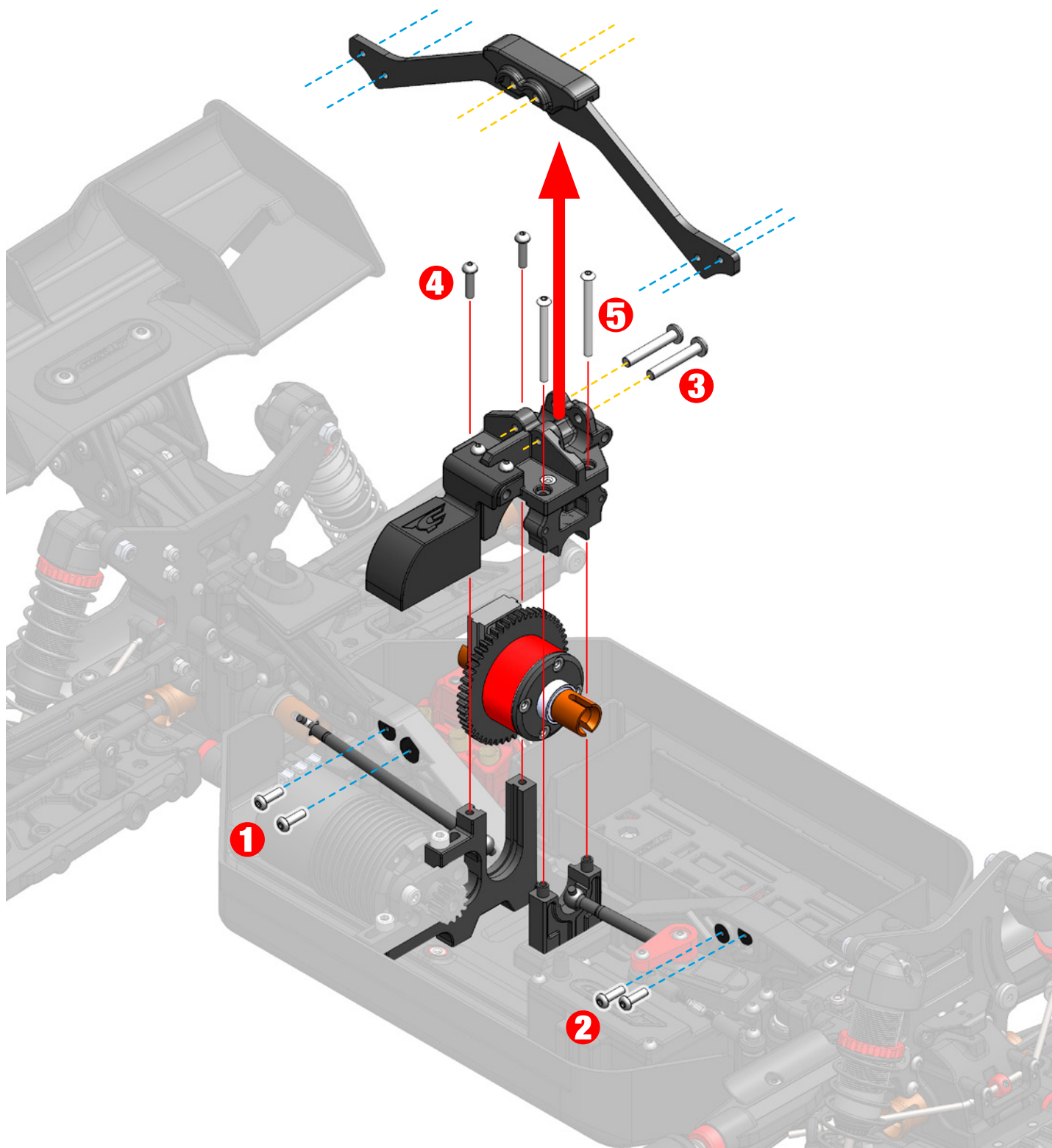

FRONT & REAR DIFFERENTIAL - DIFFÉRENTIEL AVANT ET ARRIÈRE - DIFFERENTIAL VORNE UND HINTEN - VOOR & ACHTER DIFFERENTIEEL

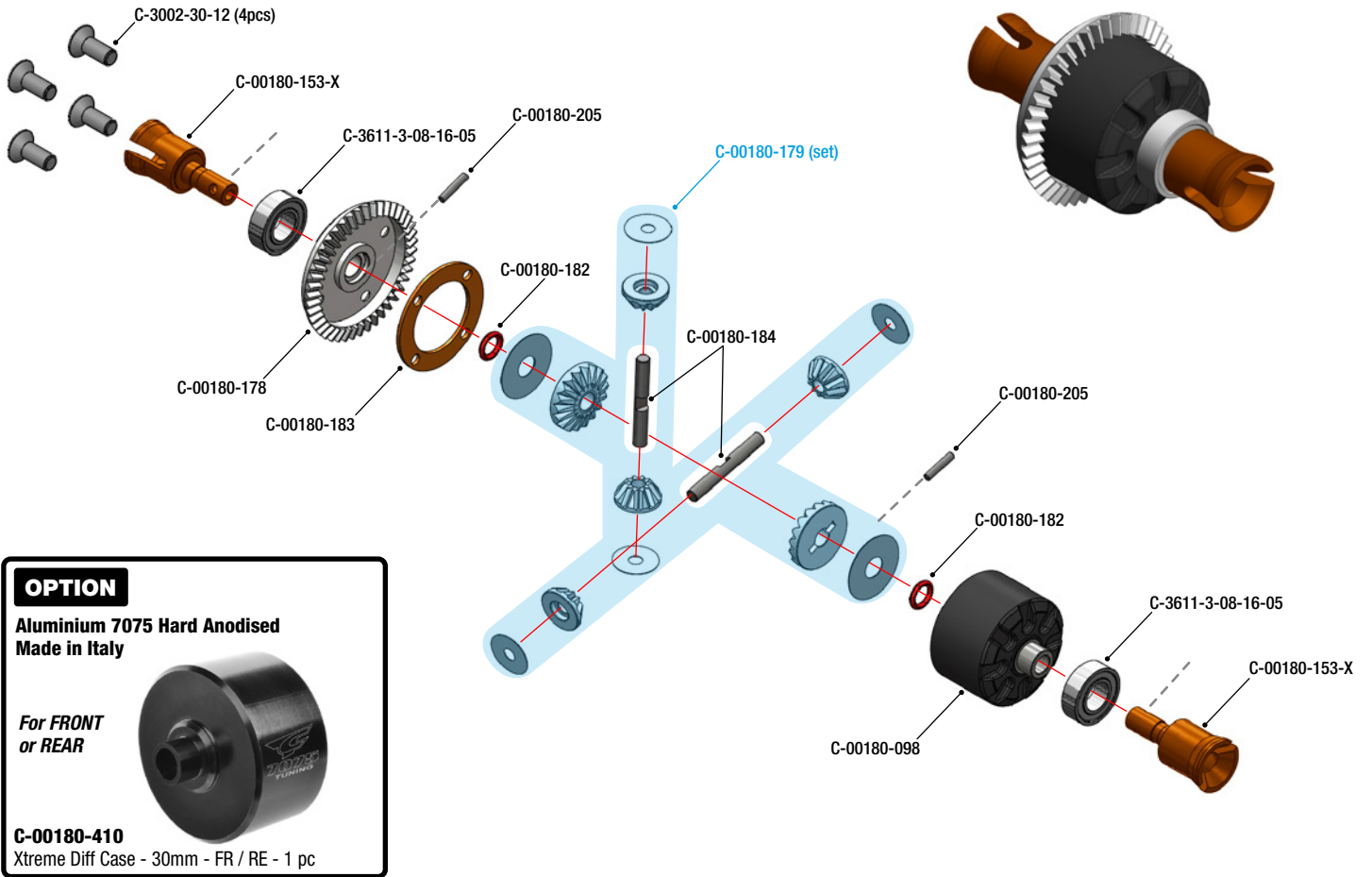

CENTRE DIFFERENTIAL - DIFFÉRENTIEL CENTRAL - ZENTRALDIFFERENTIAL - CENTERDIFFERENTIEEL

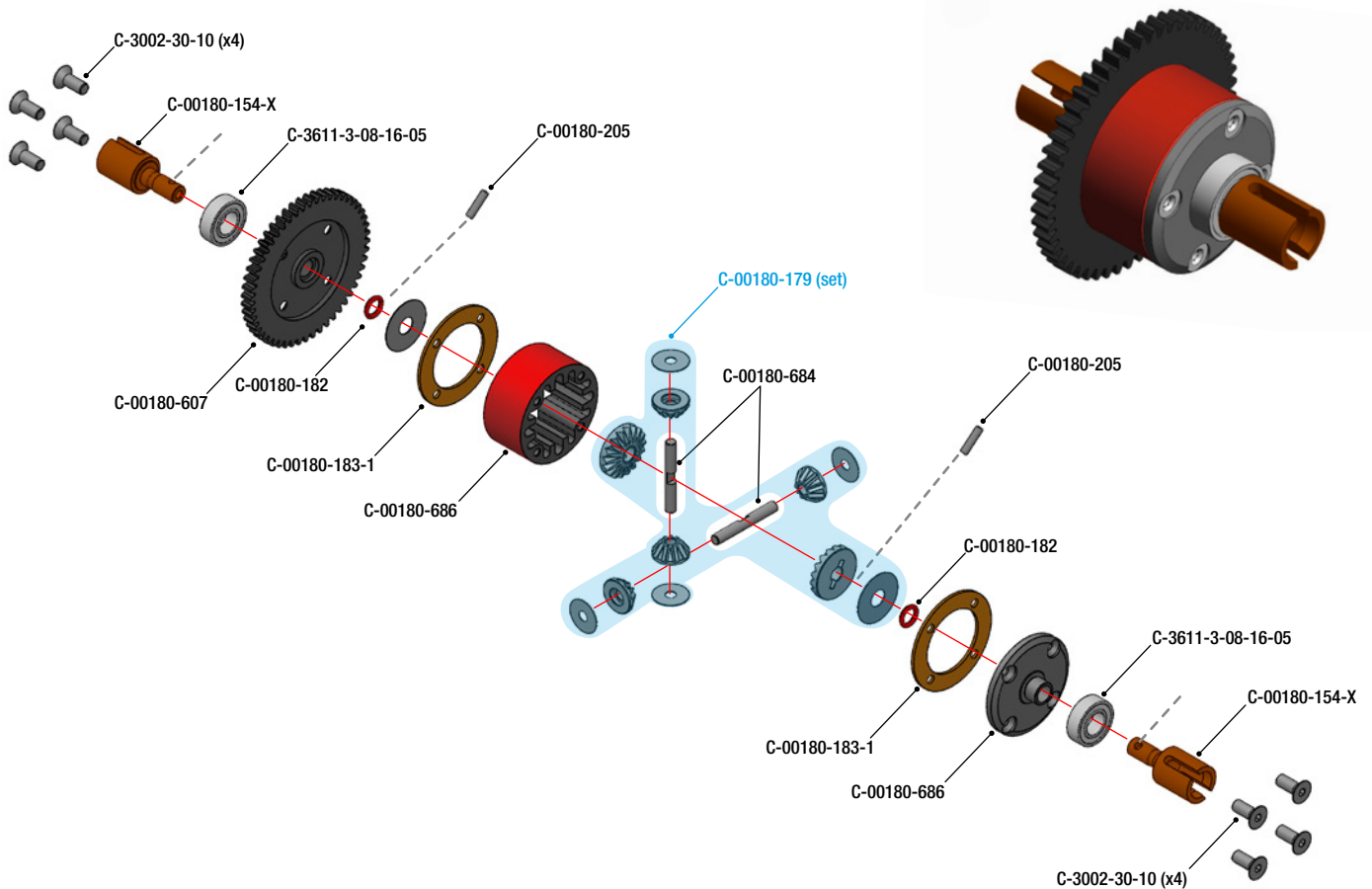



OPTION Aluminium 7075 Hard Anodised

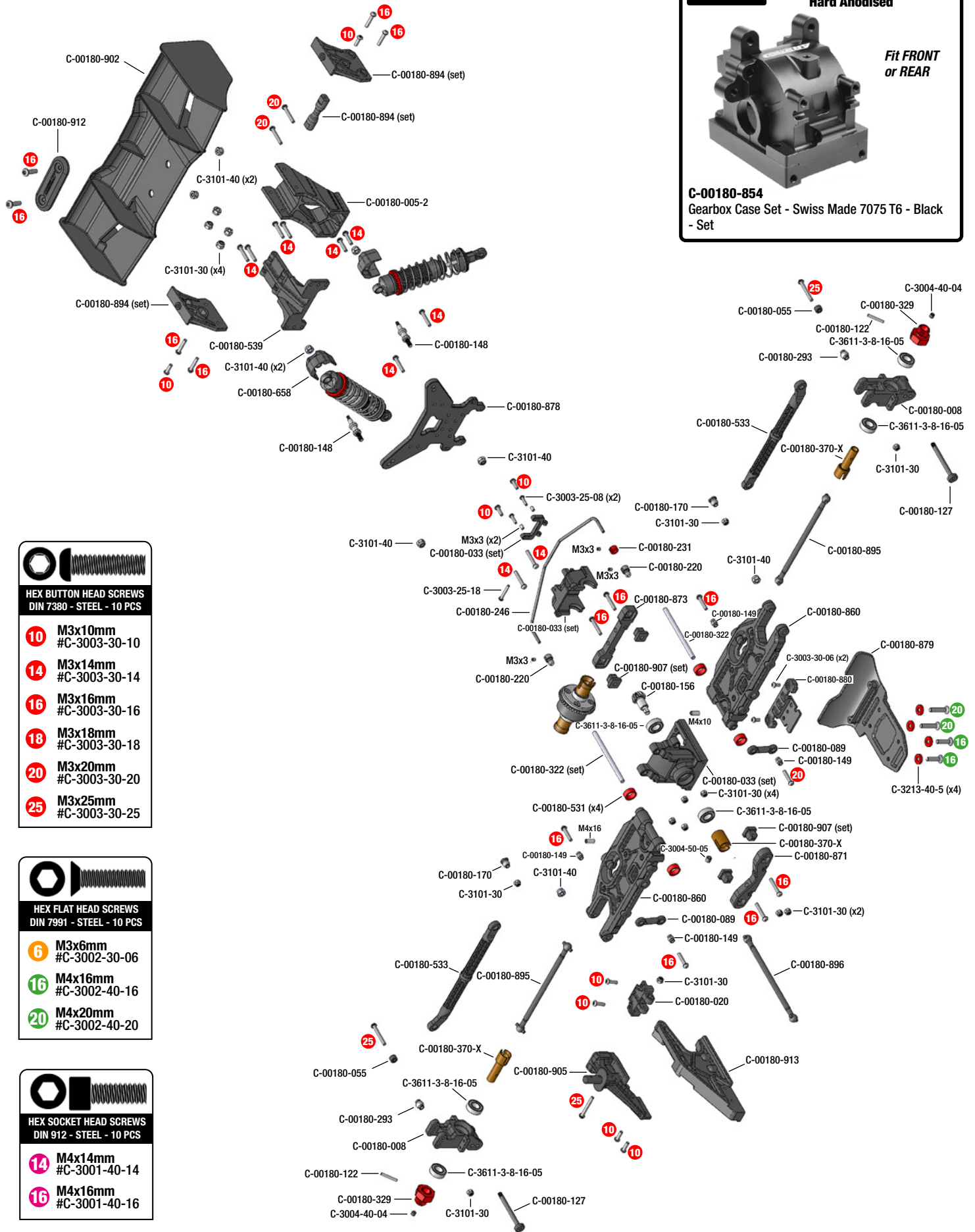

Fit FRONT or REAR

C-00180-854
Gearbox Case Set - Swiss Made 7075 T6 - Black - Set

HEX BUTTON HEAD SCREWS
DIN 7380 - STEEL - 10 PCS

- 10** M3x10mm
#C-3003-30-10
- 14** M3x14mm
#C-3003-30-14
- 16** M3x16mm
#C-3003-30-16
- 18** M3x18mm
#C-3003-30-18
- 20** M3x20mm
#C-3003-30-20
- 25** M3x25mm
#C-3003-30-25



HEX FLAT HEAD SCREWS
DIN 7991 - STEEL - 10 PCS

- 6** M3x6mm
#C-3002-30-06
- 16** M4x16mm
#C-3002-40-16
- 20** M4x20mm
#C-3002-40-20



HEX SOCKET HEAD SCREWS
DIN 912 - STEEL - 10 PCS

- 14** M4x14mm
#C-3001-40-14
- 16** M4x16mm
#C-3001-40-16

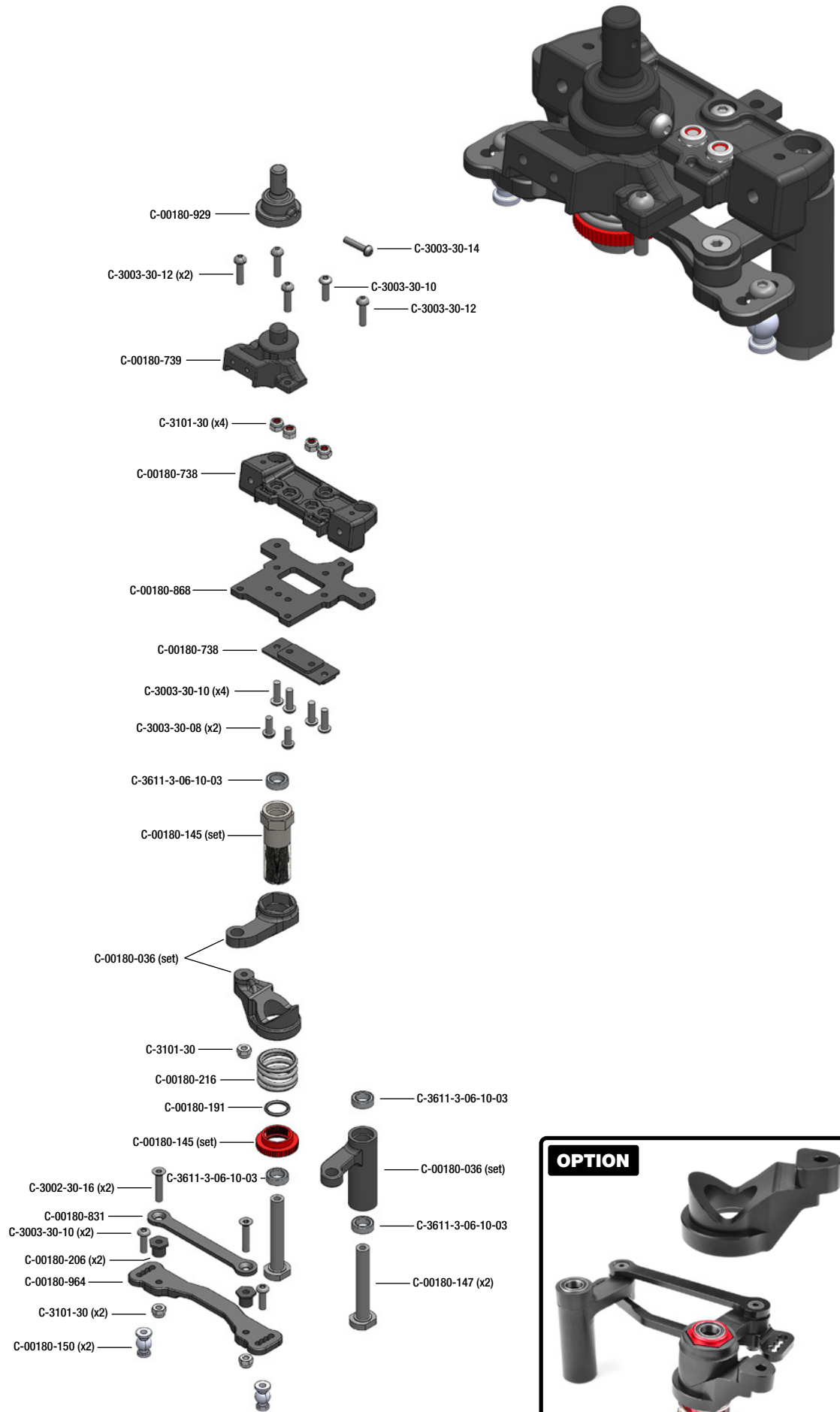



C-00180-004-1
Battery Strap - Hook & Loop
- 2 pcs



C-00180-005-2
Wing Mount - Adjustable -
Composite - 1 Set



C-00180-008
Hub - Rear - Composite - 1 pc



C-00180-009-1
HD Steering Block - Pivot Ball Cup
(2) - Composite - 1 set



C-00180-013
Servo Mount - Receiver Box -
Composite - 1 Set



C-00180-018
Centre Diff Bulkhead - Compos-
ite - 1 Set



C-00180-020
Gearbox Brace Mount A - Rear -
Composite - 1 pc

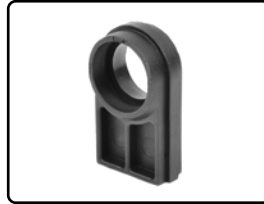

C-00180-023
Motor Mount Centre Diff Insert -
Composite - 1 pc



C-00180-033
Gearbox Case Set - Composite
- 1 Set



C-00180-036
Steering Bellcrank - Parts A-B-C
- Composite - 1 Set



C-00180-109
Caster Clips Set - 1 to 4.5mm
- 1 Set

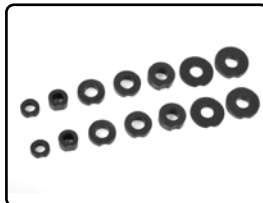

C-00180-055
Suspension Arm Shim - Com-
posite - 1 Set



C-00180-044
Ball Joint 6mm - Composite -
2 pcs



C-00180-089
Anti-Roll Bar Ball Cups - Com-
posite - 4 pcs



C-00180-117
Pivot Ball Adjusting Nut - Alu-
minium - 4 pcs

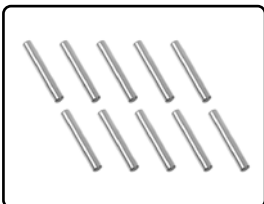

C-00180-122
Pin 2.5x17mm - Steel - 10 pcs



C-00180-123
Pivot Ball - Steel - 4 pcs



C-00180-127
Hinge Pin - Outer - Steel - 2 pcs



C-00180-129
Turnbuckle - M3 - 35mm -
Steel - 2 pcs



C-00180-145
Servo Saver Shaft w/ Nut -
Aluminium - 1 pc



C-00180-147
Servo Saver Post - Steel - 2 pcs



C-00180-148
Shock Screw - Steel - 4 pcs



C-00180-149
Ball - 5.8mm - Steel - 4 pcs



C-00180-150
Ball Shouldered - 6.8mm - Steel
- 4 pcs



C-00180-170
Ball - 6.8mm - Steel - 2 pcs



C-00180-171
Threaded Ball - 6mm - Steel -
2 pcs



C-00180-176
Motor Bulkhead - Aluminium
- 1 pc



C-00180-177
Motor Mount - Aluminium - 1 pc

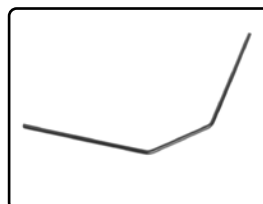

C-00180-197
Anti-Roll Bar - 2.4mm - Front
- 1 pc



C-00180-200
Anti-Roll Bar - 2.4mm - Rear
- 1 pc



C-00180-206
Steering Rack Bushing - Steel
- 2 pcs



C-00180-216
Servo Saver Spring - 1 pc



C-00180-220
Ball End 5.8mm - for Anti Roll
Bar - Steel - 4 pcs

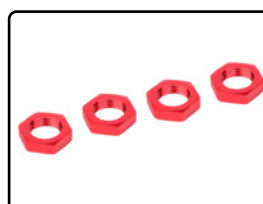

C-00180-230
Wheel Nut - Aluminium -
Ribbed - 4 pcs



C-00180-231
Collar - for Anti-roll Bar - Alu-
minium - 1 pc



C-00180-293
Ball 6.8mm - Steel - 4 pcs

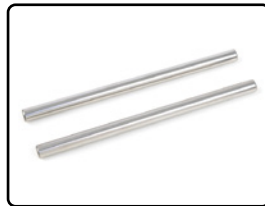

C-00180-322
Suspension Arm Pivot Pin - Lower Inner - Fr/Re - Steel - 2 pcs



C-00180-329
Wheel Hex Adapter - Wide RTR - Aluminium - 2 pcs



C-00180-372
Servo Arm - Steering - Alu - 1 pc



C-00180-562
Center Diff Spacer - 4mm - Composite - 1 pc



C-00180-615
Battery ESC Tray - V2 - Large - Composite - 1 Pc

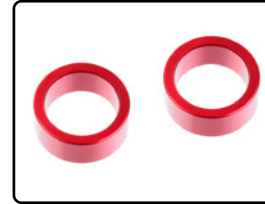

C-00180-531
HDA Suspension Arm Insert - Inner - Aluminum - Red - 2 pcs



C-00180-532
HDA Susp. Arm Insert - Outer - Spacer 1.5mm - Alu. - Red - 2 pcs

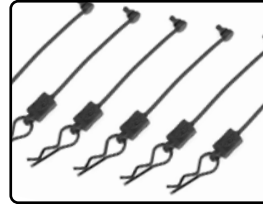

C-00180-614
Body Clip Retainer w/ Body clip - Black - 6 pcs

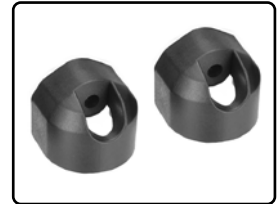

C-00180-658
Shock absorber cover - Composite - 4 pcs



C-00180-722
Center Diff Plate - Spur Gear Cover - Composite - 1 pc



C-00180-738
Arm Holder for Steering Deck - Composite - 1 Pc



C-00180-739
Steering Deck Holder - w/ Body Post - Composite - 1 pc



C-00180-831
Steering Rack - Dual Stiffener - Aluminium - 1 Pc



C-00185-856
Off-Road 1/8 XL Tires - Low Profile - Glued on Rims - 1 pair



C-00180-859
Suspension Arm HDA-3 - Lower - Front - Composite - 1 pc



C-00180-860
Suspension Arm HDA-3 - Lower - Rear - Composite - 1 pc



C-00180-861
Suspension Arm HDA-3 - Upper - Front - Composite - 1 pc

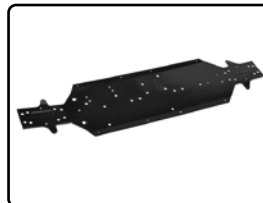

C-00180-862
Chassis - Buggy XL - Aluminum - 1 pc



C-00180-863
Side Guards - Left-Right - Composite - 1 Set



C-00180-867
Chassis Brace - Center Upper - Aluminum 3mm - Black - 1 pc

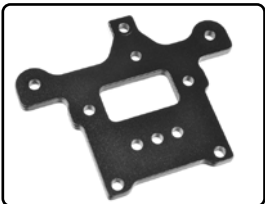

C-00180-868
Steering Deck - Aluminum - Black - 1 Pc



C-00180-869
Chassis Brace Cover - Composite - 1 pc



C-00180-870
Chassis Brace - Center Lower - Aluminum 3mm - Black - 1 pc



C-00180-871
Suspension Arm Mount HD - RE-FR - 8mm - Aluminum - Black - 1 pc



C-00180-872
Suspension Arm Mount HD - FR-RE - 8mm - Aluminum - Black - 1 pc



C-00180-873
Suspension Arm Mount HD - RE-RE - 8mm - Aluminum - Black - 1 pc



C-00180-874
Suspension Arm Mount HD - FR-FR - 8mm - Aluminum - Black - 1 pc



C-00180-877
Shock Tower - 5mm - Aluminium - Front - 1 pc



C-00180-878
Shock Tower - 5mm - Aluminium - Rear - 1 pc



C-00180-879
Bumper w/ Skid Plate - Rear - Composite - 1 pc

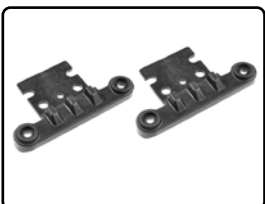

C-00180-880
Gearbox Cover - Composite - 2 pcs



C-00180-882
Bumper w/ Skid Plate - Rear - Composite - 1 pc



C-00180-891
Hinge Pin - Front Upper Arm - Steel - 2 pcs



C-00180-894
Wing Support - Left - Right - Composite - 1 Set



C-00180-902
Wing XL - Composite - 1 pc



C-00180-905
Body Post / Shock Tower Brace - Composite - 1 pc

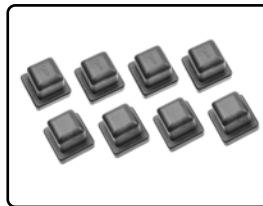

C-00180-907
Arm Holder Inserts - Composite - 0°, 1° - Set 8 pcs



C-00180-912
Wing Washer - XL - Composite - 1 Pc



C-00180-913
Chassis Brace - Rear - Composite - 1 pc



C-00180-914
Chassis Brace - Front - Composite - 1 pc



C-00180-915
Winglets for HDA-3 Front Upper Arm - Left - Right - 1 Set



C-00180-921
HD Camber Links - HDA-3 - Frontr - Composite - 2 pcs



C-00180-922
HD Camber Links - HDA-3 - Rear - Composite - 2 pcs

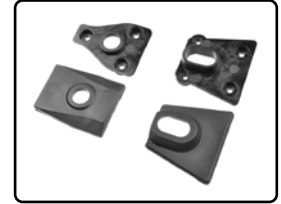

C-00180-924
Body Post Protection Plates - 1 Set



C-00180-929
Body Post Extension - Long - Composite - 1 pc



C-00180-1039
Front Lexan Support - Composite - 1 pc



C-00180-1064
Steering Block Arms - Aluminium - 2 pcs



C-00180-857-R
Body - Buggy XL - Polycarbonate - Painted RED - 1 pc

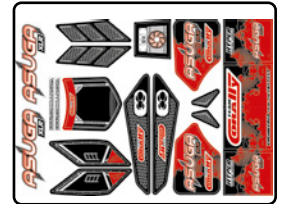

C-00180-858-R
Body Decal Sheet - Asuga XLB - RED - 1 pc



C-00180-857-B
Body - Buggy XL - Polycarbonate - Painted BLUE - 1 pc



C-00180-858-B
Body Decal Sheet - Asuga XLB - BLUE - 1 pc



C-00180-857-G
Body - Buggy XL - Polycarbonate - Painted GREEN - 1 pc

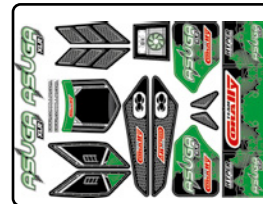

C-00180-858-G
Body Decal Sheet - Asuga XLB - GREEN - 1 pc



C-00180-857
Body - Buggy XL - Polycarbonate - CLEAR - 1 pc



C-72713
M1.0 Pinion - Hardened Steel - 13 Teeth - Shaft Dia. 5mm

FRONT & REAR DIFFERENTIAL - SPARE PARTS

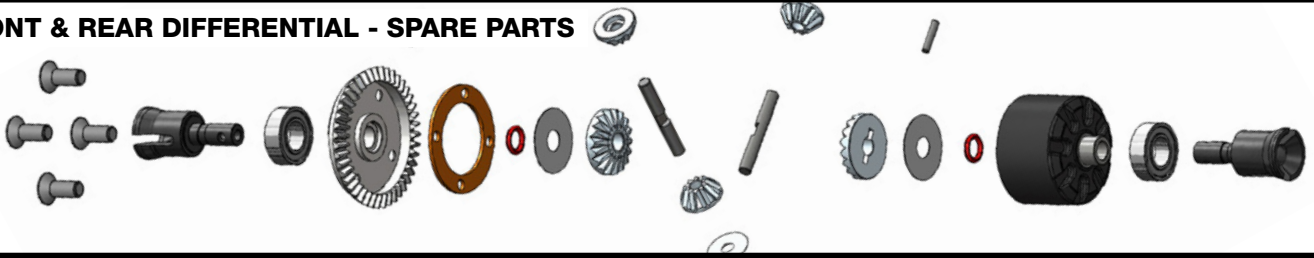

C-00180-178
Diff. Bevel Gear 43T - CNC Cut
Steel - 1 pc

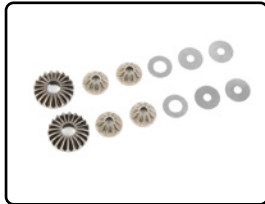

C-00180-179
Planetary Diff. Gears - Steel -
1 Set



C-00180-184
Gear Diff. Pin - Steel - 2 pcs



C-00180-205
Diff. Outdrive Pin - 2x11,8mm -
Steel - 4 pcs



C-00180-098
Diff Case - FR-RE - Composite
- 1 pc

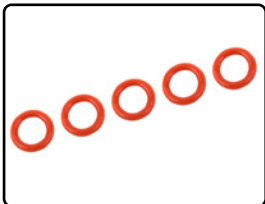

C-00180-182
O-Ring - Silicone - 5x8mm -
5 pcs

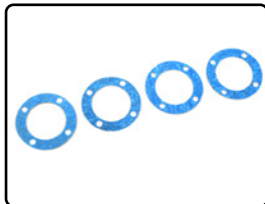

C-00180-183
Diff. Gasket - 4 pcs



C-00180-156
Bevel Pinion 13T - CNC Cut-
Steel - 1 pc



C-00180-153-X
PRO Diff. Outdrive Cup - Swiss
Spring Steel - 2 pcs



C-00180-155-X
PRO Pinion Outdrive Cup -
Swiss Spring Steel - 2 pcs



C-00180-370-X
PRO Drive Axle - Rear - Swiss
Spring Steel - 2 pcs



C-00180-895
Dogbones - 112mm - Rear -
Steel - 2 pcs



C-00180-898
Universal Joint Drive Shaft -
113,5mm - Front - 1 pc

CENTRE DIFFERENTIAL - SPARE PARTS



For use with Diff Pin C-00180-684

C-00180-686
Diff Case - Centre - Aluminium.
- 1 pc

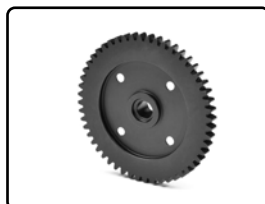

C-00180-607
Spur Gear 52T - Steel - 1 pc

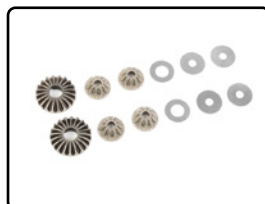

C-00180-179
Planetary Diff. Gears - Steel -
1 Set



For use with C-00180-686

C-00180-684
Gear Diff Pin - 3.5x29.8mm -
for C-00180-686 - Steel - 4 pcs



C-00180-183-1
Central Diff. Gasket - 4 pcs

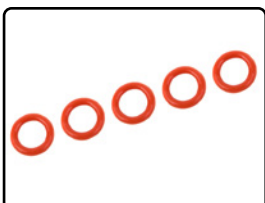

C-00180-182
O-Ring - Silicone - 5x8mm -
5 pcs



C-00180-154-X
PRO Centre Diff. Outdrive Cup -
Swiss Spring Steel - 2 pcs

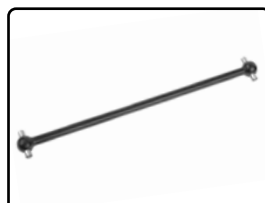

C-00180-896
Drive Shaft - Centre - Rear -
109mm - Steel - 1 pc



C-00180-897
Drive Shaft - Centre - Front -
134mm - Steel - 1 pc

SHOCK ABSORBER - SPARE PARTS



C-00180-133
Shock Cap - Aluminium - Hard Anodised - 2 pcs

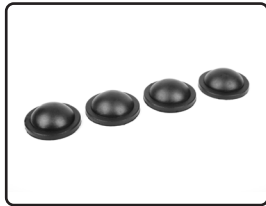

C-00180-189
Shock Bladders - Silicone - 4 pcs

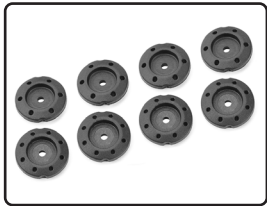

C-00180-768
Shock Piston Heavy Duty - 4mm thick - 8x1.2 + 6x1.4 - 1 Set

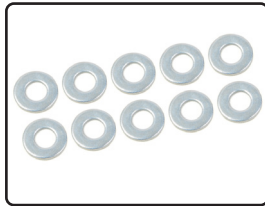

C-00180-190
Shock Washer - 2.5x6x0.5mm - Steel - 10 pcs



C-00180-164
Shock Shaft - 66mm - Rear - Steel - 2 pcs



C-00180-166
Shock Shaft - 61mm - Front - Steel - 2 pcs



C-00180-134
Shock Body - Rear - Aluminium - Hard Anodised - 1 pc



C-00180-137
Shock Body - Front - Aluminium - Hard Anodised - 1 pc

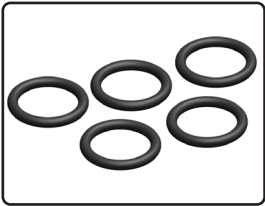

C-00180-191
O-Ring - Silicone - 9x12mm - 5 pcs

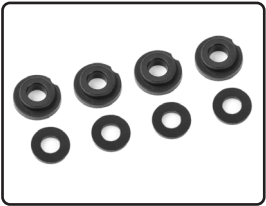

C-00180-078
Shock Body Insert - Washer - Composite - 1 set



C-00180-188
O-Ring - Silicone - 4x8mm - 5 pcs



C-00180-138
Shock Cap - Lower - Composite - 2 pcs

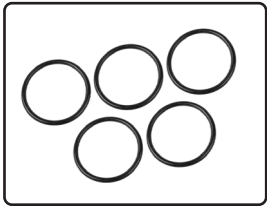

C-00180-192
O-Ring - Silicone - 16.2x19.8mm - 5 pcs

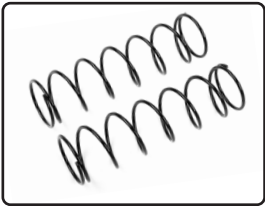

Shock Spring - 2 pcs
C-00180-290 • FRONT - MED
C-00180-291 • FRONT - HARD

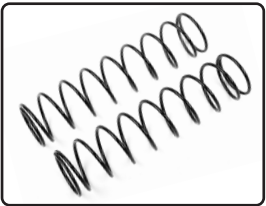

Shock Spring - 2 pcs
C-00180-287 • REAR - MED.
C-00180-288 • REAR - HARD

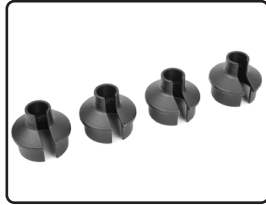

C-00180-029
Shock Spring Cup - Composite - 4 pcs

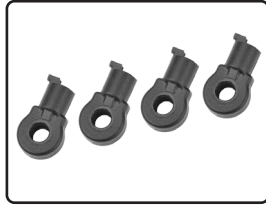

C-00180-770
HD Shock End - Short - Composite - 4 pcs



C-00180-136
Shock Collar - Aluminium - Hard Anodised - 2 pcs

OPTION PARTS - PIÈCES D'OPTION - OPTIONSTEILE - OPTIES



Fit with C-00180-903
C-00180-892
Turnbuckle - M5 - 70mm - S2 Springsteel - 2 pcs



Fit with C-00180-892
C-00180-903
HD Steering Ball Joint - Composite - 1 set



C-00180-316
Shock Cap - Lower - Aluminium - 2 pcs



Aluminium 7075 Hard Anodised
C-00180-854
Gearbox Case Set - Swiss Made 7075 T6 - Black - Set



Aluminium 7075 Hard Anodised
Made in Italy
C-00180-410
Xtreme Diff Case - 30mm - FR / RE - Made in Italy - 1 pc



C-54055
Brushless Motor - Kuron 825 - 4-Pole - 2050 KV - Sensorless



C-54011
Speed Controller - TOROX 185 - Brushless - 2-6S



IP-67
C-52015
OC-27 HV Digital Servo - 5-8.4V - IP-67 - Core DC Motor - Steel Gear



C-52001
High Speed Servo - High Voltage - Coreless Motor - Titanium Gear



C-00180-157
Wing Washer - Lightened - Aluminium - 2 pcs

STEEL SCREWS

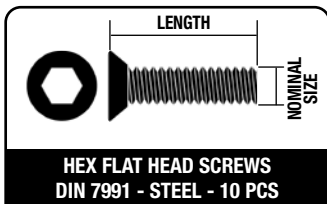

REF	NOMINAL SIZE	LENGTH MM
C-3002-25-06	M2.5	6
C-3002-25-08	M2.5	8
C-3002-25-10	M2.5	10
C-3002-25-12	M2.5	12
C-3002-25-16	M2.5	16
C-3002-25-18	M2.5	18
C-3002-25-20	M2.5	20
C-3002-30-06	M3	6
C-3002-30-08	M3	8
C-3002-30-10	M3	10
C-3002-30-12	M3	12
C-3002-30-14	M3	14
C-3002-30-16	M3	16
C-3002-30-18	M3	18
C-3002-30-20	M3	20
C-3002-30-25	M3	25
C-3002-30-35	M3	35
C-3002-40-08	M4	8
C-3002-40-10	M4	10
C-3002-40-12	M4	12
C-3002-40-14	M4	14
C-3002-40-16	M4	16
C-3002-40-18	M4	18
C-3002-40-20	M4	20
C-3002-40-25	M4	25
C-3002-40-30	M4	30

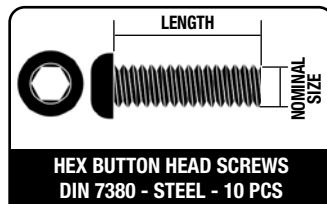

REF	NOMINAL SIZE	LENGTH MM
C-3003-25-06	M2.5	6
C-3003-25-08	M2.5	8
C-3003-25-10	M2.5	10
C-3003-25-12	M2.5	12
C-3003-25-16	M2.5	16
C-3003-25-18	M2.5	18
C-3003-25-20	M2.5	20
C-3003-30-06	M3	6
C-3003-30-08	M3	8
C-3003-30-10	M3	10
C-3003-30-12	M3	12
C-3003-30-14	M3	14
C-3003-30-16	M3	16
C-3003-30-18	M3	18
C-3003-30-20	M3	20
C-3003-30-25	M3	25
C-3003-30-35	M3	35
C-3003-40-08	M4	8
C-3003-40-10	M4	10
C-3003-40-12	M4	12
C-3003-40-14	M4	14
C-3003-40-16	M4	16
C-3003-40-18	M4	18
C-3003-40-20	M4	20
C-3003-40-25	M4	25
C-3003-40-30	M4	30

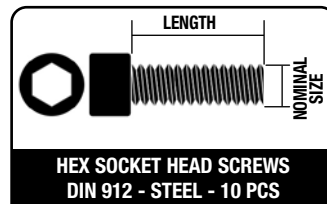

REF	NOMINAL SIZE	LENGTH MM
C-3000-25-06	M2.5	6
C-3000-25-08	M2.5	8
C-3000-25-10	M2.5	10
C-3000-25-12	M2.5	12
C-3000-25-16	M2.5	16
C-3000-25-18	M2.5	18
C-3000-25-20	M2.5	20
C-3000-30-06	M3	6
C-3000-30-08	M3	8
C-3000-30-10	M3	10
C-3000-30-12	M3	12
C-3000-30-14	M3	14
C-3000-30-16	M3	16
C-3000-30-18	M3	18
C-3000-30-20	M3	20
C-3000-30-25	M3	25
C-3000-30-35	M3	35
C-3000-40-08	M4	8
C-3000-40-10	M4	10
C-3000-40-12	M4	12
C-3000-40-14	M4	14
C-3000-40-16	M4	16
C-3000-40-18	M4	18
C-3000-40-20	M4	20
C-3000-40-25	M4	25
C-3000-40-30	M4	30

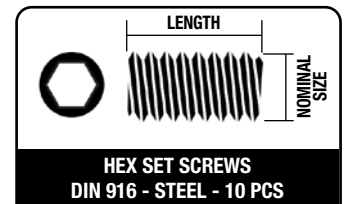

REF	NOMINAL SIZE	LENGTH MM
C-3004-30-03	M3	3
C-3004-30-05	M3	5
C-3004-30-08	M3	8
C-3004-30-10	M3	10
C-3004-30-12	M3	12
C-3004-30-20	M3	20
C-3004-40-04	M4	4
C-3004-40-06	M4	6
C-3004-40-08	M4	8
C-3004-40-10	M4	10
C-3004-40-12	M4	12
C-3004-50-04	M5	4
C-3004-50-05	M5	5

TITANIUM SCREWS

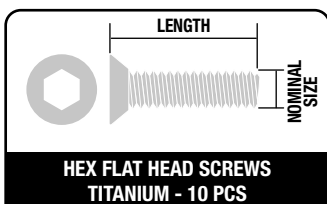

REF	NOMINAL SIZE	LENGTH MM
C-3022-30-06	M3	6
C-3022-30-08	M3	8
C-3022-30-10	M3	10
C-3022-30-12	M3	12
C-3022-30-14	M3	14
C-3022-30-16	M3	16
C-3022-30-18	M3	18
C-3022-30-20	M3	20
C-3022-40-08	M4	8
C-3022-40-10	M4	10
C-3022-40-12	M4	12
C-3022-40-16	M4	16
C-3002-40-20	M4	20

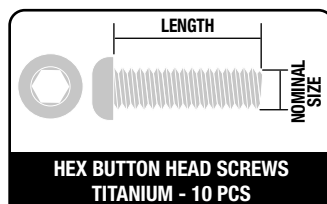

REF	NOMINAL SIZE	LENGTH MM
C-3023-30-06	M3	6
C-3023-30-08	M3	8
C-3023-30-10	M3	10
C-3023-30-12	M3	12
C-3023-30-16	M3	16
C-3023-30-20	M3	20
C-3023-30-25	M3	25
C-3023-40-06	M4	6
C-3023-40-08	M4	8
C-3023-40-10	M4	10
C-3023-40-12	M4	12
C-3023-40-16	M4	16
C-3023-40-20	M4	20
C-3023-40-25	M4	25

NUTS

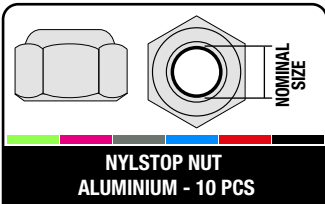

REF	NOMINAL SIZE	COLOR
C-3106-20-0	M2	Gold
C-3106-20-1	M2	Green
C-3106-20-2	M2	Purple
C-3106-20-3	M2	Gun
C-3106-20-4	M2	Blue
C-3106-20-5	M2	Red
C-3106-20-6	M2	Black
C-3106-30-0	M3	Gold
C-3106-30-1	M3	Green
C-3106-30-2	M3	Purple
C-3106-30-3	M3	Gun
C-3106-30-4	M3	Blue
C-3106-30-5	M3	Red
C-3106-30-6	M3	Black
C-3106-40-0	M4	Gold
C-3106-40-1	M4	Green
C-3106-40-2	M4	Purple
C-3106-40-3	M4	Gun
C-3106-40-4	M4	Blue
C-3106-40-5	M4	Red
C-3106-40-6	M4	Black
C-3106-50-0	M5	Gold
C-3106-50-1	M5	Green
C-3106-50-2	M5	Purple
C-3106-50-3	M5	Gun
C-3106-50-4	M5	Blue
C-3106-50-5	M5	Red
C-3106-50-6	M5	Black

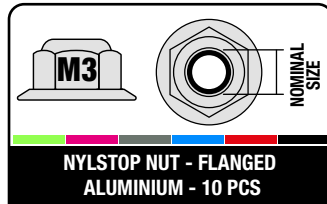

REF	NOMINAL SIZE	COLOR
C-3107-30-0	M3	Gold
C-3107-30-1	M3	Green
C-3107-30-2	M3	Purple
C-3107-30-3	M3	Gun
C-3107-30-4	M3	Blue
C-3107-30-5	M3	Red
C-3107-30-6	M3	Black
C-3107-40-0	M4	Gold
C-3107-40-1	M4	Green
C-3107-40-2	M4	Purple
C-3107-40-3	M4	Gun
C-3107-40-4	M4	Blue
C-3107-40-5	M4	Red
C-3107-40-6	M4	Black
C-3107-50-0	M5	Gold
C-3107-50-1	M5	Green
C-3107-50-2	M5	Purple
C-3107-50-3	M5	Gun
C-3107-50-4	M5	Blue
C-3107-50-5	M5	Red
C-3107-50-6	M5	Black

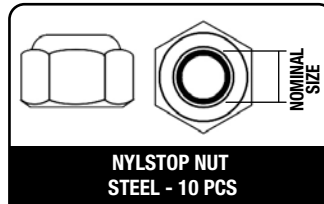

REF	NOMINAL SIZE	COLOR
C-3101-20-6	M2	Black
C-3101-25	M2.5	Silver
C-3101-25-6	M2.5	Black
C-3101-30	M3	Silver
C-3101-30-6	M3	Black
C-3101-40	M4	Silver
C-3101-40-6	M4	Black

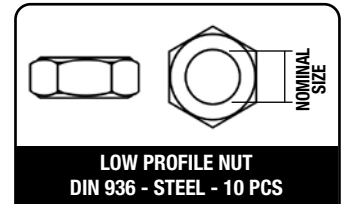

REF	NOMINAL SIZE	COLOR
C-3104-40	M4	Silver
C-3104-50	M5	Silver

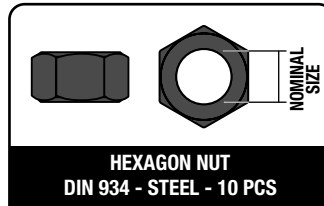

REF	NOMINAL SIZE	COLOR
C-3103-20-6	M2	Black
C-3103-25-6	M2.5	Black
C-3103-30-6	M3	Black
C-3103-40-6	M4	Black
C-3103-50-6	M5	Black

BALL BEARINGS

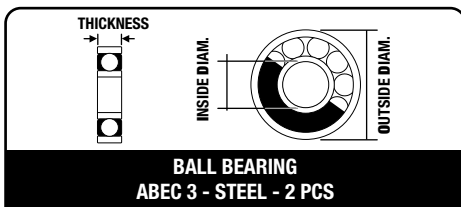

REF	ID MM	OD MM	TH MM
C-3611-3-05-08-03	5	8	3
C-3611-3-05-10-04	5	10	4
C-3611-3-06-10-03	6	10	3
C-3611-3-08-16-05	8	16	5
C-3611-3-10-15-04	10	15	4
C-3611-3-12-21-05	12	21	5

SHIMS

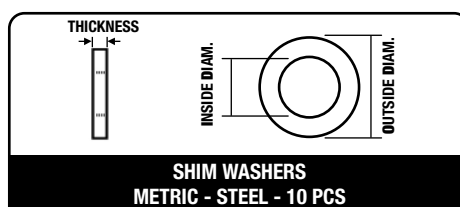

REF	ID MM	OD MM	TH MM
C-3301-04-06-01	4	6	0.1
C-3301-06-08-01	6	8	0.1
C-3301-08-10-01	8	10	0.1
C-3301-13-16-01	13	16	0.1

STEELWASHERS

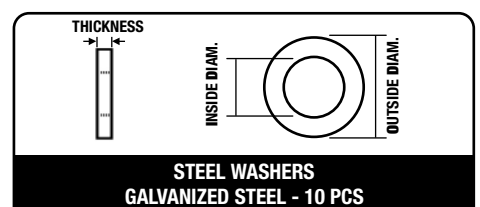

REF	ID MM	OD MM	TH MM
C-3201-30	3.2	7	0.5
C-3201-40	4.3	9	0.8
C-3201-60	6.4	12	1.6

Discover our range of practical plastic boxes with a selection of the most commonly used Screws, Nuts, Shims, Washers.



C-38500
Screw Set M3 - Hex Button Head - DIN 7380 - Steel Black - 10.9 Grade - 15 Sizes - 375 pcs



C-38501
Screw Set M4 - Hex Button Head - DIN 7380 - Steel Black - 10.9 Grade - 15 Sizes - 265 pcs



C-38505
Screw Set M3 - Hex Flat Head - DIN 7991 - Steel Black - 10.9 Grade - 15 Sizes - 375 pcs



C-38506
Screw Set M4 - Hex Flat Head - DIN 7991 - Steel Black - 10.9 Grade - 15 Sizes - 265 pcs



C-38510
Screw Set M3 - Hex Socket Head - DIN912 - Steel Black - 12.9 Grade - 15 Sizes - 375 pcs



C-38511
Screw Set M4 - Hex Socket Head - DIN912 - Steel Black - 12.9 Grade - 15 Sizes - 265 pcs



C-38515
Screw Set - Set Screws - M3 - M4 - M5 - DIN 916 - Steel Black - 12.9 Grade - 10 Sizes - 370 pcs



C-38516
Nuts - Lock Nuts - Washers Set - M2 - M2.5 - M3 - M4 - Steel Black - 10 Sizes - 320 pcs



970pcs

C-38516
Universal Sport Car Series - Screws - Nuts Set - 34 Sizes - 970 pcs



C-38520
Shim Ring Set - Steel - 15 Sizes - 375pcs

More info

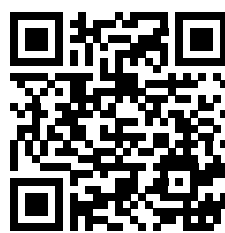

www.corally.com

FACTORY PRO TOOL



Factory Pro Tool - Hardened Tip - Alu Grip - Hex

TEAM CORALLY - SHOCK PLIERS

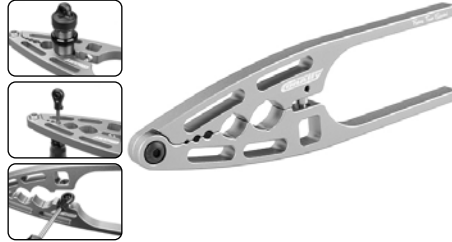

Team Corally - Shock Pliers

PINION CADDY M1.0



Team Corally - Pinion Caddy M1.0 - 9 Pinions - ø5mm

TEAM CORALLY - GREASE



Lithium Grease - Blue Grease - Ball Diff Grease - Copper Grease

TEAM CORALLY - SILICONE OILS



Shock Oils 60ml - 150ml - CST or WT - 100 >1000 CPS
Diff Oils 60ml - 2000 >2 000 000 CPS

TEAM PIT GEAR



A range of quality equipment for the transport and protection of your equipment.

TEAM CORALLY - PINIONS

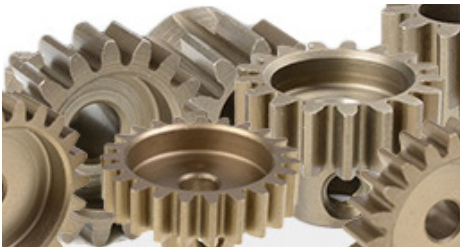

Discover our range of Precision CNC-Cut MOD-1.0 Pinions for motors with a ø 5.0mm motor shaft

SPORT RACING - LIPO



Team Corally - Sport Racing 50C - 4S or 6S - XT-90 - Hard Case

ELECTRONIC



A range of high quality electronic equipment for the best performance.



Discover all these products and more on the website www.corally.com
Découvrez tous ces produits et bien plus encore sur le site web www.corally.com
 Entdecken Sie all diese Produkte und mehr auf der Website www.corally.com
 Ontdek al deze producten en meer op de website www.corally.com

This manual is an edition of Corally, a division of JSP GROUP INTL nv, Geelseweg 80, B-2250 Olen, Belgium. This manual is protected by a copyright and nothing from this edition may be reproduced or used without any prior written authorisation. Whilst every effort has been made to ensure the accuracy of the information in this manual, errors creep in and Corally can accept no responsibility for failures, wrong specifications, accuracy of colours, losses or damages caused. Corally denies any responsibility claims or damages caused by use of our products. Corally is not responsible for product / parts / specifications / Colour changes or availability of these products.

WWW.CORALLY.COM

TEAM
CORALLY

WORLD CHAMPIONS



WWW.CORALLY.COM

Team Corally is a registered trademark licensed to
JSP Group Intl bvba • Geelseweg 80 • B-2250 OLEN • Belgium
Tel: +32 14 25 92 94 • Info@corally.com